

ISO 9001: 2008 Certified Company

Registered Office Address :

- 
-  **Address** 3/76 Hararwalla Building,
Near Alankar Theatre,
Mumbai -400 004. Maharashtra (India)
 -  **Phone** +91 22 66363282
 -  **Mobile** + 91- 9869340517
 -  **Email** info@dineshtube.com
 -  **Website** www.dineshtube.com

Dinesh Tube (India) is a dynamic group, which was established over a decade ago to cater to growing demands of stainless steel raw materials. We have a team of young visionaries who endeavour for excellence in every aspect related to our products. As importers, exporter, dealers & stockiest with huge stocks Dinesh Tube (India) become within one of the most reliable source for quality within a short span. We are registered with the best of semi-govt., govt., private & multinational companies. Our aim is to provide our buyers with everything in stainless steel under one roof viz. Dinesh Tube (India).

Dinesh Tube (India) has tied up with one of the best manufacturers of steel in order to supply high quality & testified material/products to our customers at competitive rates. We can arrange for material against CT3/ARE4/H forms for exports. As registered dealers, we provide Modvat invoices so that you can avail of excise benefits. We can help you import any material/product strictly adhering to you preference & quality constraints. We can arrange for chemical, physical, mechanical, ultrasonic, micro, IGC and any other related test from govt. approved laboratories. We are even ready for any third party inspection of our material/product.

Out Vision

To become globally the most reliable business partner in steel

Out Mission

To create long term business relationships with growth oriented corporations by delivering superior quality and eco-friendly products.

To become a star export house recognised by government of india.

To become a approved supplier of all mnics and growth oriented corporations of india.

QUALITY ASSURANCE PLAN

Quality Assurance plans are prepared in accordance with specific requirements stated by the customer and respective ASTM specifications, Mandatory and supplementary requirements are translated to special instructions and audits performed during manufacture and inspection.

Inspection stages and check hold points are decided to carry out in process inspection and record important stages of inspection and tests.

ORGANISATION: *A separate Quality Assurance/Control Department functions under the control of management, independent of production. The Quality Assurance Department oversees all important quality functions and performs the following activities.*



MATERIAL CONTROL SYSTEM: *This system controls the quality of all incoming material. The incoming material specifications are co-related with Raw Material test certificates of the material. The checks and test are documented. The material is given internal control No. and same is recorded for future reference.*

PROCESS CONTROL SYSTEMS: *During forming, Forging and Heat treatment, process control system outlines inprocess checks and controls to be followed during heat treatment and testing. Forging and interim heat treatment in the process control reduces the chances of introduction of variables in the process.*

Each lot of fittings as defined in ASTM specifications are subjected to heat treatment and testing. Testing is performed in accordance with specification requirements. Test data is evaluated by QA department and recorded in appropriate format, supplementary test like radiography, ultrasonic, corrosion testing etc. is done as per code guide lines.

MACHINING AND DIMENSIONAL CONTROL: *Suitable fixtures and templates are used to maintain dimensional accuracy. Necessary gauges and callipers are calibrated periodically to maintain their accuracy.*

FINISHING PAINTING & MARKING: *Carbon and alloy steel fitting are shot ballasted or pickled and painted. Stainless steel fittings are pickled and passivated. All fittings are marked with size, schedule, specification and manufacturer stamp.*

Equipment calibration and audits are done as per quality plans.

CERTIFICATION & SUPPLEMENTARY TEST: *Fittings supplied to the QAP are supplied with test certificate. Test certificate incorporates, Chemical, Mechanical and Hardness properties, also it gives details of Heat treatment, Hydro test pressure, Supplementary test and stamping details.*

Additional information and test data is furnished as per customer requirement.

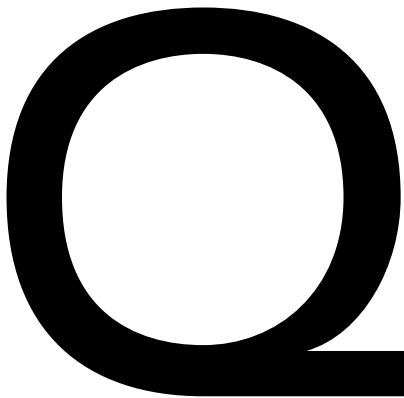

(NICKEL BASE ALLOYS) GUIDE TO APPLICATIONS

NICKEL 200	Commercial pure wrought Nickel for the construction of chemical plant
NICKEL 201	A low-carbon grade of nickel free from the stress- corrosion cracking associated with graphitisation in chemical plant operating at temperatures above 300° C, e.g. caustic soda plant.
NICKEL 205	A high-purity nickel for anodes, plants and grids of electronic valves and for megnetostrictive transducers.
NICKEL 212	Slightly stiffer than pure nickel, used for electrode support wires in radio valves and tungsten filament lamps.
NICKEL 222	A cathode nickel for the sleeves of indirectly heated, oxide-coated cathodes in radio valves.
NICKEL 270	A high-purity nickel with a minimum temperature - coefficient of resistant of 0.006°c over the range 0.100°C. Made by the powder metallurgy process. Used for components of special valves., such as hydrogen thyratons and for electric resistance thermometers and controls.
MONEL alloy 400	A general engineering alloy with good resistance to corrosion by sea water, sulphuric, hydrochloric and phosphoric acids, pharmaceutial products, ammonium sulphate, fatty acids, etc. It retains its strength and toughness up to about 4500°c and is used for chemical, steam and petroleum plant, marine and pickling equipment,
MONEL alloysK-500	An alloy with similar corrosion-resistance to MONEL alloy 400 but amenable to precipitation hardening to give high strength. Used for propeller and pump shafts, bolts, doctor blades and valve spindles.
CAST MONEL alloys	Cast alloy pig supplied for foundry addition to silicon. For corrosion-resistance castings.
INCONEL alloy 600	This alloy has excellent mechanical properties and oxidation-resistance at high temperatures. It is used for furnace parts, heat-treatment equipment, heating element sheating in nuclear engineering and in the construction of chemical plant.
INCONEL alloy 625	An alloy with high strength and toughness from cryogenic temperatures to 100°C in addition to good oxidation-resistance. It resist attack by other media and is virtually immune to chlo ride-stress corrotion cracking. It is used in aerospace and is being evaluated for chemical and marine engineering.
INCOLOY alloy 800	This alloy resist hydrogen/hydrogen sulphide corrosion and chlorides stress corrosion cracking. It is based for pigtails and headers and hydrocarbon “cracker” tubes for other high-temperature processing equipment.
INCOLOY alloy 825	This product resist corrosion by acids and alkalies in either reducing or oxidising conditions. It is resistant to stress-corrosion cracking and pitting and used for chemical plant and pickling plant. A nickel iron cobalt alloy combining a low coefficient of expansion and higher inflexion temperature with higher strength than is usual in this composition range. It is being evaluated for such applications as diesel engine piston crowns compensating members in gas turbine engines and controlled clearance rotating machinery parts.
INCOLOY alloy Ds	A general purpose heat resisting alloy with particular resistance to carburisation and alternating carburisation and oxdition. It is used for furnace parts, heat treatment and vitreous enamelling equipment.

NICKEL BASE ALLOYS

NOMINAL CHEMICAL COMPOSITION, % (not for specification purposes)													
Nickel	Ni	C	Mn	Fe	S	Si	Cu	Cr	Co	Mo	Al	Ti	Other
Nickel	99.5	0.08	0.018	0.2	0.005	0.18	0.13	-	-	-	-	-	-
Nickel201	99.5	0.01	0.018	0.2	0.005	0.18	0.13	-	-	-	-	-	-
Nickel205	99.5	0.08	0.018	0.010	0.004	0.08	0.08	-	-	-	-	0.03 Mg	0.05
Nickel212	97.7	0.010	2.0	0.05	0.005	0.05	0.03	-	-	-	-	-	-
Nickel222	99.5	0.01	0.02	0.04	0.0025	0.01	0.01	0.01	0.06	0.01	0.01	Mg0.08	-
Nickel270	99.98	0.01	0.003	<0.001	<0.001	<0.001	<0.001	<0.001	-	-	<0.001	Mg<0.001	-
	Ni	C	Mn	Fe	S	Si	Cu	Cr	Co	Mo	Ai	Ti	Other
MONEL alloy 400	63.0 min	0.15	1.0	25max	0.024max	0.05max	31.0	-	-	-	-	-	-
MONEL alloy 500	63.0 min	0.015	1.5 max	2.0max	0.010max	0.5	30.0	-	-	-	2.9	0.6	-
Cast MONEL alloy	63.0 min	0.07	0.75	2.5max	0.02 max	0.04max	30.0	0.10max	-	0.20max	0.05max	0.01max	-
Cast MONEL alloy	63.0 min	0.03max	0.020max	2.5max	0.02max	0.04max	30.0	0.10	-	0.20max	0.05max	0.01max	-
	Ni	C	Mn	Fe	S	Si	Cu	Cr	Co	Mo	Ai	Ti	Other
INCONEL alloy 600	72.0MIN	0.15MAX	1.0MAX	8.0	0.015 max	0.05max	0.05 max	15.5	-	-	-	-	Nb + Ta
INCONEL alloy 625	60.5	0.10max	0.25	5.0max	0.015max	0.5 max	-	21.5	-	9.0	0.25	0.25	3.65
	Ni	C	Mn	Fe	S	Si	Cu	Cr	Co	Mo	Ai	Ti	Other
INCOLOY alloy 800	32.5	0.10max	1.5max	Bal.	0.015max	1.0max	0.75 max	21.0	-	-	0.38	0.38	-
INCOLOY alloy 825	42.0	0.05max	1.0max	Bal.	0.03 max	0.5max	2.25	21.5	-	3.0	0.20max	0.9	-
INCOLOY alloy 904	32.5	0.025	0.025	Bal.	0.015	0.25	0.25	-	14.5	-	0.1	1.6	-
INCOLOY alloy DS	37.0	1.2	1.2	Bal.	-	2.3 max	2.3 max	18.0	-	-	-	0.20	-
	Ni	C	Mn	Fe	S	Si	Cu	Cr	Co	Mo	Ai	Ti	Other
Hastalloy B	Rest/Bal	0.10	0.80	5.58	0.7	Rest	0.6	1.25	28	-	-	-	-
Hastalloy C	Rest/Bal	0.07	0.80	5.75	0.7	Rest	16.0	1.25	17 -	-	-	-	-
Hastalloy G Alloy	Rest/Bal	0.05	1.0-2.0	18.0-21.0	0.7	Rest	1.5 21-23.5	1.25	5.575	-	-	-	-

PHYSICAL AND MECHANICAL PROPERTIES

Nickel	Density Kg/mm ² C	Melting range at 20°C	Specific heat Conductivity J/Kg C	Thermal expansion at 20°C W/m C	Thermal resistivity 10-c/C 20-95°C	Electrical Strength at 20°C Mocroh m cm	Tensile HV N/mm ²	Hardness
Nickel 200	8.89	1435-1445	456	74.9	13.3	9.5	380-550	90-120
Nickel 201	8.89	1435-1445	456	79.2	13.3	7.6	340-420	75-100
Nickel 205	8.89	1435-1445	456	74.9	13.3	9.5	340	77
Nickel 212	8.89	1435-1445	430	44.1	-	10.9	476	144
Nickel 222	8.89	1435-1445	456	74.9	13.3	8.8	340	77
Nickel 270	8.89	1435-1445	460	85.7	13.3	7.5	340	80
	Density	Melting range	Specific heat	Thermal expansion	Thermal resistivity	Electrical Strength	Tensile	Hardness
MONEL alloy 400	8.83	1300-1350	419	21.7	14.1	51.0	480-620	111-151
MONEL alloy K-500	8.46	1315-1350	419	17.4	13.7	61.4	620-760	141-189
	Density	Melting range	Specific heat	Thermal expansion	Thermal resistivity	Electrical Strength	Tensile	Hardness
INCONEL alloy 600	8.42	1370-1425	461	14.8	13.3	103	550-690	121-173
INCONEL alloy 625 8.	8.44	1290-1350	410	9.8	12.8	129	830-1040	146-247
	Density	Melting range	Specific heat	Thermal expansion	Thermal resistivity	Electrical Strength	Tensile	Hardness
INCOLOY alloy 800	7.95	1355-1385	502	11.7	14.2	99	520-700	121-188
INCOLOY alloy 825	8.14	1370-1400	441	10.9	14.0	113	590-730	121-183
INCOLOY alloy 904	8.12	-	442	14.9	4.6	72	923	-
INCOLOY alloy DS	7.92	1330-1400	452	12.0	14.1	108	680	208

STAINLESS STEEL PIPE, SCHEDULE, DIMENSION,

DESIGNATION		O/D	NOMINAL WALL THICKNESS														
OF DIAMETER		DIA	SCH.5S		SCH.5		SCH.10S		SCH.10		SCH.20S.		SCH.30		SCH.40S		SCH. 40
(A)	(B)	METER MM	WALL THK	WEIGHT KG/MTR	WALL THK	WEIGHT KG/MTR	WALL THK	WEIGHT KG/MTR	WALL THK	WEIGHT KG/MTR	WALL THK	WEIGHT KG/MTR	WALL THK	WEIGHT KG/MTR	WALL THK	WEIGHT KG/MTR	WALL THK
6	1/8	10.3	1.0	0.23			1.2	0.27			1.5	.33			1.73	0.37	
8	1/4	13.7	1.2	0.37			1.65	0.49			2.00	.58			2.24	0.64	
10	3/8	17.2	1.2	0.47			1.65	0.63			2.00	.74			2.31	0.87	
15	1/2	21.3	1.65	0.81	1.65	0.81	2.11	1.02	2.11	1.02	2.5	1.15			2.77	1.29	
20	3/4	26.7	1.65	1.03	1.65	1.03	2.11	1.30	2.11	1.30	2.5	1.49			2.87	1.71	
25	1	33.4	1.65	1.31	1.65	1.31	2.77	2.13	2.77	2.13	3.00	2.24			3.38	2.54	
32	1 1/4	24.2	1.65	1.67	1.65	1.67	2.77	2.73	2.77	2.73	3.00	2.90			3.56	3.44	
40	1 1/2	48.3	1.65	1.93	1.65	1.93	2.77	3.16	2.77	3.16	3.00	3.35			3.68	4.11	
50	2	60.3	1.65	2.42	1.65	2.42	2.77	3.99	2.77	3.99	3.5	4.90			3.91	5.52	
65	2 1/2	73.0	2.11	3.75	2.11	3.75	3.05	5.34	3.05	5.34	3.5	6.00			5.16	8.77	
80	3	88.9	2.11	4.59	2.11	4.59	3.05	6.56	3.05	6.56	4.00	8.37			5.49	11.47	
90	3 1/2	101.6	2.11	5.25	2 1/1	5.25	3.05	7.53	3.05	7.53	4.00	9.62			5.74	13.78	
100	4	114.3	2.11	5.93	2.11	5.93	3.05	8.50	3.05	8.50	4.5	12.18			6.02	6.32	
125	5	141.3	2.77	9.61	2.77	9.61	3.40	11.74	3.40	11.74	5.00	16.80			6.55	22.10	
150	6	168.3	2.77	11.47	2.77	11.47	3.40	14.04	3.40	14.04	5.5	22.08			7.11	28.69	
200	8	219.1	2.77	15.00	2.77	15.00	3.76	20.77	3.76	20.27	6.35	33.82	7.04	37.38	8.18	43.20	
250	10	273.1	3.40	22.95	3.40	22.95	4.19	28.20	4.19	28.20	6.35	42.41	7.80	51.81	9.27	61.22	
300	12	323.9	3.96	31.72	4.19	33.60	4.57	36.54	4.57	36.54	6.35	50.48	8.38	66.20	9.53	75.01	10.31
350	14	355.6	3.96	34.86			4.78	41.99	6.35	55.53	7.92	68.95	9.53	82.58	9.53	82.58	11.13
400	16	406.4	4.19	42.20			4.78	48.07	6.35	63.61	7.92	79.03	9.53	94.70	9.53	94.70	12.70
450	18	457.2	4.19	47.46			4.78	54.15	6.35	71.69	7.92	89.10	11.13	124.32	9.53	106.83	14.27
500	20	508.0	4.78	60.23			5.54	69.70	6.35	79.76	9.53	118.93	12.70	157.51	9.53	118.9	15.06
550	22	558.8	4.78	65.95			5.54	76.75	6.35	87.84	9.53	131.07	12.70	173.66	9.53	131.07	15.88
600	24	609.6	5.54	83.80			6.35	95.92	6.35	95.92	9.53	143.20	14.27	212.72	9.53	143.20	17.45
650	26	660.4							7.92	129.40	12.70	205.97			9.53	155.32	
700	28	711.2							7.92	139.47	12.70	222.13	15.88	276.48	9.53	167.44	
750	30	762.0	6.35	120.15			7.92	149.55	7.92	149.55	12.70	238.28	15.88	296.68	9.53	179.56	
800	32	812.8							7.92	159.62	12.70	254.44	15.88	316.88	9.53	191.69	17.48
850	34	863.6							7.92	169.64	12.70	270.50	15.88	336.96	9.53	203.74	17.48
900	36	914.4							7.92	179.77	12.70	286.75	15.88	357.28	9.53	215.93	19.05

WALL THICKNESS, WEIGHT/METER

NOMINAL WALL THICKNESS																
SCH 60		SCH 80 S		SCH.80		SCH.100		SCH.120		SCH.140		SCH.160		SCH.XXS		
WEIGHT KG/MTR	WALL THK	WEIGHT KG/MTR	WALL THK	WEIGHT KG/MTR	WALL THK	WEIGHT KG/MTR	WALL THK	WEIGHT KG/MTR	WALL THK	WEIGHT KG/MTR	WALL THK	WEIGHT KG/MTR	WALL THK	WEIGHT KG/MTR	WALL THK	WEIGHT KG/MTR
			2.41	0.47												
			3.02	0.82												
			3.20	1.12												
			3.73	1.64									4.75	1.97	7.47	2.59
			3.91	2.93									5.54	2.93	7.82	3.69
			4.55	3.29									6.35	4.30	9.09	5.53
			4.85	4.53									6.35	5.69	9.70	7.88
			5.08	5.49									7.14	7.35	10.16	9.69
			5.54	7.60									8.71	11.26	11.07	13.65
			7.01	11.59									9.53	15.15	14.02	20.72
			7.62	15.51									11.13	21.67	15.24	28.11
			8.08	18.92											16.15	34.56
			8.56	22.66					11.13	28.75			13.49	34.05	17.12	41.66
			9.53	31.44					12.70	40.90			15.88	49.87	19.05	58.31
			10.97	43.21					14.27	55.03			18.24	68.53	21.95	79.1
	10.81	53.90	12.70	65.63			15.06	76.93	18.24	91.73	20.62	102.47	23.01	112.97	22.23	108.00
	12.20	82.80	12.70	82.80	15.06	97.27	18.24	116.38	21.41	134.90	25.40	157.51	28.58	174.95	25.40	155.5
80.94	14.27	110.62	12.70	98.95	17.45	133.88	21.41	162.14	25.40	189.82	28.58	211.31	33.32	242.40	25.40	189.82
96.00	15.06	128.42	12.70	109.04	19.05	160.54	23.80	197.74	27.76	227.88	31.75	257.47	35.71	286.04		
125.20	16.66	162.59	12.70	125.20	21.41	206.40	26.19	249.34	30.94	290.88	36.53	338.32	40.46	370.74		
158.27	19.05	209.00	12.70	141.35	23.80	258.29	29.36	314.54	34.93	369.34	39.67	414.74	45.24	466.67		
185.89	20.62	251.65	12.70	157.51	26.19	315.97	32.54	387.41	38.10	448.30	44.45	515.94	49.99	573.31		
216.04	22.23	298.55	12.70	173.66	28.57	379.70	34.92	457.83	41.27	535.17	47.62	609.30	53.97	682.57		
258.74	24.59	360.21	12.70	189.82	30.94	448.30	38.89	555.76	46.02	649.44	52.37	730.72	59.51	819.70		
			12.70	205.97	24.66D-t) t											
			12.70	222.13	1000											
			1270	238.28	Wt/pam + formula											
348.11			12.70	254.44	Weight stainless steel pipe											
370.22			12.70	270.50	OD (mm) - W.T. (mm) XW.T. (mm) X 0.02466 = Kg. per mtr.											
427.09			12.70	286.75												

STAINLESS STEEL PIPE & TUBE KG/MTRS

N.B	O.D	Schedule		Schedule		Schedule		Schedule		Schedule		Schedule	
		5 S		10 S		40 S		80 S		160		XX-Strong	
		Wall											
Inch	mm	mm	kg/m	mm	kg/m	mm	kg/m	mm	kg/m	mm	kg/m	mm	kg/m
1/8"	10.29			1.24	0.281	1.73	0.371	2.41	0.476				
1/4"	13.72			1.65	0.498	2.24	0.643	3.02	0.809				
3/8"	17.15			1.65	0.640	2.31	0.858	3.20	1.12				
1/2"	21.34	1.65	0.814	2.11	1.01	2.77	1.29	3.73	1.65	4.78	1.98	7.47	2.59
3/4"	26.67	1.65	1.033	2.11	1.30	2.87	1.71	3.91	2.23	5.56	2.94	7.82	3.69
1"	33.40	1.65	1.31	2.77	2.12	3.38	2.54	4.55	3.29	6.35	4.30	9.10	5.53
1 1/4"	42.16	1.65	1.67	2.77	2.73	3.56	3.44	4.85	4.53	6.35	5.59	9.70	7.88
1 1/2"	48.26	1.65	1.925	2.77	3.15	3.68	4.11	5.08	5.49	7.14	7.35	10.16	9.69
2"	60.33	1.65	2.424	2.77	3.99	3.91	5.52	5.54	7.60	8.74	11.29	11.07	13.65
2 1/2"	73.03	2.11	3.75	3.05	5.34	5.16	8.77	7.01	11.6	9.53	15.15	14.02	20.71
3"	88.90	2.11	4.58	3.05	6.56	5.49	11.5	4.62	15.5	11.13	21.67	15.24	28.11
3 1/2"	101.60	2.11	5.26	3.05	7.53	5.74	13.8	8.08	18.9				
4"	114.30	2.11	5.93	3.05	8.50	6.02	16.3	8.56	22.7	13.49	34.05	17.12	41.66
5"	141.30	2.77	9.61	3.40	11.74	6.55	22.1	9.53	31.4	15.88	49.87	19.05	58.31
6"	168.28	2.77	11.48	3.40	14.0	7.11	28.7	10.97	43.2	18.26	68.59	21.95	80.43
8"	219.08	2.77	15.00	3.76	20.27	8.18	43.2	12.70	65.5	23.01	113.01	22.22	109.57
10"	273.05	3.40	22.96	4.19	28.21	9.27	61.23	12.70	82.79	28.58	174.90	25.40	157.51
12"	323.85	3.96	31.72	4.57	36.54	9.53	74.93	12.70	98.95	33.32	242.53	25.40	189.81
14"	355.60	3.96	34.9	4.78	41.9								
16"	406.40	4.19	49.2	4.78	48.1								
18"	457	4.19	47.5	4.78	54.2								
20"	508	4.78	60.2	5.54	69.9								
24"	610	5.54	83.9	6.35	96.0								

N.B	O.D	Schedule 20 ¹⁾		Schedule 120 ¹⁾		DN	DIN 2440, O.D mm	for threading Wall mm	Din 2633, Welding neck flanges	
		Wall mm	kg/mm	mm	kg/m				Tube O.D Group 1,mm	Tube O.D Group2, mm
Inch	mm	mm	kg/mm	mm	kg/m					
4"	114.30			11.13	28.8	6	10.2	2.0		
5"	141.30			12.70	40.9	8	13.5	2.35		
6"	168.28			14.27	55.0	10	17.2	2.35	17.2	14
8"	219.08	6.35	33.8	18.26	91.8	15	21.3	2.65	21.3	20
10"	273.08	6.35	42.4	21.44	135.1	20	26.9	2.65	26.9	25
12"	323.85	6.35	50.4	25.40	189.8	25	33.7	3.25	33.7	30
14"	355.60	7.92	68.9	27.79	228.1	32	42.4	3.25	42.4	38
16	406.40	7.92	79.0			40	48.3	3.25	48.3	44.5
18"	457.20	7.92	89.1			50	60.3	3.65	60.3	57
20."	508	9.53	118.9			65	76.1	3.65	76.1	
24"	610	9.53	143.3			80	88.9	4.05	88.9	
						100	114.3	4.5	114.3	108

ANSI B 36.10

Gauge	BWG Birmingham/Stubs Iron Wire and Sheets		SWG Imperial / Legal Standards Wire Gauge	
	inch	mm	inch	mm
14	0.0830	2.108	0.0800	2.032
16	0.0650	1.651	0.0640	1.626
18	0.0490	1.245	0.0480	1.219
20	0.0350	0.889	0.0360	0.914

125	139.7	4.85	139.7	133
150	165.1	4.85	168.3	159
175			193.7	
200			219.1	
250			273	267
300			323.9	
350			355.6	368
400			406.4	419

Here is a digest of two German specification showing DN. These tables are given for guidance only. The fitting catalogue S-1131-ENG gives further information about DIN 2633.

Alternations in the programme may be made without further notice

TOLERANCE: ASTM SPECIFICATION FOR TUBING & PIPING

Specification	Allowable Outside Diameter Variation in mm			Allowable Wall Thickness Variation		Exact Length Testing Tolerance in mm		
	Nominal Diameter	Over	Under	%Over	%Under	Over	Under	
ASTM-A213 Seamless Boiler Superheater and Heat Exchanger Tubes	Under 25.4	.1016	.1016	+20	-0	3.175	0	Tension Test Flattening Test Flare Test Hardness Test 100% Hydrostatic test Refer to ASTM A-450
	25.4-38.1 incl	.1524	.1524	+22	-0	3.175	0	
	38.1-50.8 excl	.2032	.2032	+22	-0	3.176	0	
	50.8-63.5 excl	.254	.254	+2	-0	4.46	0	
	63.5-76.2 excl	.3048	.3048	+22	-0	4.76	0	
76.2-101.6 incl	.381	.381	+22	-0	4.76	0		
ASTM-A249 Welded Boiler Superheater, Heat Exchanger And Condenser Tubes	Under 25.4	.1016	.1016	+10	-10	3.175	0	Tension Test Flattening Test Flare Test Reverse Bend Test Hardness Test 100% Hydrostatic Test *Reverse flattening Test Refer to ASTM A-450 *Wherever applicable
	25.4-38.1 incl	.1524	.1524	+10	-10	3.175	0	
	38.1-50.8 Excl	.2032	.2032	+10	-10	3.175	0	
	50.0-63.5 excl	.254	.254	+10	-10	4.76	0	
	63.5-76.2 excl	.3848	.3048	+10	-10	4.76	0	
76.2-101.6 incl	.381	.381	+10	-10	4.76	0		
ASTM-A269 Seamless & Welded Tubing for General Service	Untp 12.7	.13	.13	+15	-15	3.2	0	Flare Test Flance Test (Welded Only) Hardness Test Reverse Flattening Test (Welded only) 100% Hydrostatic Test Refer to ASTM-A269
	12.7-38.1 excl	.13	.13	+10	-10	3.2	0	
	38.1-88.9 excl	.25	.25	+10	-10	4.8	0	
	88.9-139.7 excl	.38	.38	+10	-10	4.8	0	
	139.7-203.2 excl	.76	.76	+10	-10	4.8	0	
ASTM-A270 Semless & Welded Sanitary Tubing	25.4	.05	.20	+12.5	-12.5	3.2	0	Reverse flattening Test 100% Hydrostastic Test Externa' polish on all tubes Refer to ASTM A-270
	38.1	.05	.20	+12.5	-12.5	3.2	0	
	50.8	.05	.28	+12.5	-12.5	3.2	0	
	60.5	.05	.28	+12.5	-12.5	3.2	0	
	76.2	.08	.30	+12.5	-12.5	3.2	0	
	101.6	.08	.38	+12.5	-12.5	3.2	0	
ASTM-A312 Semless & Welded pipe	3.175-38.1 incl	.4	.79	Minimum Wall 12.5% under nominal wall Specified		6.4	0	Tension Test Flattening Test 100% Hydrostatic Test Refer to ASTM A-530
	38.1-1016 incl	.79	.79			6.4	0	
	101.6-203.2 imcl	1.59	.79			6.4	0	
						(Normally Random Lengths ordered)		
ASTM A-358 Welded pipe	219.08-750mm or 0.01 inch	+0.5%		-0.3		6.0		Refer to ASTM A-530



CHEMICAL COMPOSITION OF S. S. PIPES & TUBES

Grade	UNS Designation	Composition %															
		Carbon max	Manganese max	Sulfur max	Phosphorus max	Silicon	Nickel	Chromium	Molybdenum	Titanium	Columbium plus Tantalum	Tantalum max	Nitrogen ^c	Vanadium	Copper	Cerium	Boron
TP304	S30400	0.08	2.00	0.040	0.030	0.75 max	8.00-11.0	18.0-20.0	--	--	--	--	--	--	--	--	--
TP304H	S30409	0.04-0.10	2.00	0.040	0.030	0.75 max	8.00-11.0	18.0-20.0	--	--	--	--	--	--	--	--	--
TP304L	S30403	0.035	2.00	0.040	0.030	0.75 max	8.00-13.0	18.0-20.0	--	--	--	--	--	--	--	--	--
TP304N	S30451	0.08	2.00	0.040	0.030	0.75 max	8.00-11.0	18.0-20.0	--	--	--	--	0.10-0.16	--	--	--	--
TP304LN	S30453	0.035	2.00	0.040	0.030	0.75 max	8.00-11.0	18.0-20.0	--	--	--	--	0.10-0.18	--	--	--	--
TP309Cb	S30940	0.08	2.00	0.045	0.030	0.75 max	12.0-16.0	22.0-24.0	0.75 max	--	10 x C min 1.10 max	--	--	--	--	--	--
TP309H	S30909	0.04-0.10	2.00	0.040	0.030	0.75 max	12.0-15.0	22.0-24.0	--	--	--	--	--	--	--	--	--
TP309HCb	S3041	0.04-0.10	2.00	0.045	0.030	0.75 max	12.0-16.0	22.0-24.0	0.75 max	--	10 x C min 1.10 max	--	--	--	--	--	--
TP309S	S30908	0.08	2.00	0.045	0.030	0.75 max	12.0-15.0	22.0-24.0	0.75 max	--	--	--	--	--	--	--	--
TP310Cb	S31040	0.08	2.00	0.045	0.030	0.75 max	19.0-22.0	24.0-26.0	0.75 max	--	10 x C min 1.10 max	--	--	--	--	--	--
TP310H	S31009	0.04-0.10	2.00	0.040	0.030	0.75 max	19.0-22.0	24.0-26.0	--	--	--	--	--	--	--	--	--
TP310HCb	S31041	0.04-0.10	2.00	0.045	0.030	0.75 max	19.0-22.0	24.0-26.0	0.75 max	--	10 x C min 1.10 max	--	--	--	--	--	--
TP310S	S31008	0.08	2.00	0.045	0.030	0.75 max	19.0-22.0	24.0-26.0	0.75 max	--	--	--	--	--	--	--	--
	S31272	0.08-0.12	1.5	0.030	0.015	0.3-0.7	14.0-16.0	14.0-16.0	1.0-1.4	0.3-0.6	--	--	--	--	--	--	0.04
TP316	S31600	0.08	2.00	0.040	0.030	0.75 max	11.0-14.0	16.0-18.0	2.00-3.00	--	--	--	--	--	--	--	0.00
TP316H	S31609	0.04-0.10	2.00	0.040	0.030	0.75 max	11.0-14.0	16.0-18.0	2.00-3.00	--	--	--	--	--	--	--	--
TP316L	S31603	0.035	2.00	0.040	0.030	0.75 max	10.0-15.0	16.0-18.0	2.00-3.00	--	--	--	--	--	--	--	--
TP316N	S31651	0.08	2.00	0.040	0.030	0.75 max	11.0-14.0	16.0-18.0	2.00-3.00	--	--	--	0.10-0.16	--	--	--	--
TP316LN	S31653	0.035	2.00	0.040	0.030	0.75 max	11.0-14.0	16.0-18.0	2.00-3.00	--	--	--	0.10-0.18	--	--	--	--
TP317	S31700	0.08	2.00	0.040	0.030	0.75 max	11.0-14.0	18.0-20.0	3.00-4.00	--	--	--	--	--	--	--	--
TP317L	S31703	0.035	2.00	0.040	0.030	0.75 max	11.0-15.0	18.0-20.0	3.00-4.00	--	--	--	--	--	--	--	--
TP321	S32100	0.08	2.00	0.040	0.030	0.75 max	9.00-13.0	17.0-20.0	--	F	--	--	--	--	--	--	--
TP321H	S32109	0.04-0.10	2.00	0.040	0.030	0.75 max	9.00-13.0	17.0-20.0	--	G	--	--	--	--	--	--	--
TP347	S34700	0.08	2.00	0.040	0.030	0.75 max	9.00-13.0	17.0-20.0	--	H	--	--	--	--	--	--	--
TP347H	S34709	0.04-0.10	2.00	0.040	0.030	0.75 max	9.00-13.0	17.0-20.0	--	I	--	--	--	--	--	--	--
TP347LN	S34751	0.005-0.020	2.00	0.040	0.030	0.75 max	9.00-13.0	17.0-20.0	--	--	0.2-0.5 ^H	--	0.06-0.10	--	--	--	--
TP348	S34800	0.08	2.00	0.040	0.030	0.75 max	9.00-13.0	17.0-20.0	--	--	H	0.10	--	--	--	--	--
TP348H	S34809	0.04-0.10	2.00	0.040	0.030	0.75 max	9.00-13.0	17.0-20.0	--	--	I	0.10	--	--	--	--	--
TPXM 10	S21900	0.08-0.10	8.00-10.00	0.040	0.030	1.00 max	5.50-7.50	19.0-21.5	--	--	--	--	0.15-0.40	--	--	--	--
TPXM 11	S21904	0.04-0.10	8.00-10.00	0.040	0.030	1.00 max	5.50-7.50	19.0-21.5	--	--	--	--	0.15-0.40	--	--	--	--
TPXM-15	S38100	0.08	2.00	0.030	0.030	1.50-2.50	17.5-18.5	17.0-19.0	--	--	--	--	--	--	--	--	--
TPXM-19	S20910	0.060	4.00-6.00	0.040	0.030	1.00 max	11.5-13.5	20.5-3.00	1.50-3.00	--	0.10-0.30	--	0.20-0.40	0.10-0.30	--	--	--
TPXM-29	S24000	0.080	11.5-14.5	0.060	0.030	1.00 max	2.25-3.75	17.0-19.0	--	--	--	--	0.20-0.40	--	--	--	--
---	S31254	0.020	1.00	0.030	0.010	0.80 max	17.5-18.5	19.5-20.5	6.00-6.50	--	--	--	0.18-0.22	--	0.50-1.00	--	--
---	S30615	0.16-0.24	2.00	0.030	0.030	3.2-4.0	13.5-16.0	17.0-19.5	--	--	--	--	--	--	--	--	--
---	S30815	0.05-0.10	0.80	0.040	0.030	1.40-2.00	10.0-12.0	20.0-22.0	--	--	--	--	0.14-0.20	--	--	--	0.03-0.08
---	S31050	0.025	2.00	0.020	0.015	0.4	20.5-23.5	24.0-26.0	1.6-2.6	--	--	--	0.09-0.15	--	--	--	--
---	S30600	0.018	2.00	0.020	0.020	3.7-4.3	14.0-15.5	17.0-18.5	0.20 max	--	--	--	--	--	0.50 max	--	--
---	S31725	0.03	2.00	0.040	0.030	0.75	13.5-17.5	18.0-20.0	4.0-5.0	--	--	--	0.10 max	--	0.75 max	--	--
---	S31726	0.03	2.00	0.040	0.030	0.75	13.5-17.5	17.0-20.0	4.0-5.0	--	--	--	0.10-0.20	--	0.75 max	--	--
---	S32615	0.07	2.00	0.045	0.030	4.8-6.0	19.0-22.0	16.5-19.5	0.3-1.5	--	--	--	--	--	1.5-2.5	--	--
---	S33228	0.04-0.08	1.00	0.020	0.015	0.30 max	31.0-33.0	26.0-28.0	--	--	0.6-1.0	--	--	--	--	0.05-0.10	--
---	S24565	0.03	5.0-7.0	0.030	0.010	1.00max	16.0-18.0	23.0-25.0	4.0-5.0	--	0.1 max	--	0.04-0.6	--	--	--	--
---	S30415	0.4-0.06	0.80	0.045	0.030	1.00-2.00	9.00-10.0	18.0-19.0	--	--	--	--	0.12-0.16	--	--	--	0.03-0.08
---	S32654	0.020	2.00-4.00	0.030	0.005	0.50 max	21.0-23.0	24.0-25.0	7.00-8.00	--	--	--	0.45-0.55	--	0.030-0.60	--	--
---	S35315	0.04-0.08	2.00	0.045	0.030	0.75	34.0-36.0	24.0-26.0	--	--	--	--	0.12-0.18	--	--	--	0.03-0.08
---	N08367	0.030	2.00	0.030	0.030	1.00 max	23.50-25.50	20.00-22.00	6.00-7.00	--	--	--	0.18-0.25	--	0.75 max	--	--
---	N08904	0.020	2.00	0.045	0.035	1.00	23.0-28.0	19.0-23.0	4.0-5.0	--	--	--	0.10 max	--	1.0-2.0	--	--

New designation established in accordance with Practice E 527 and SAE J 1086.

Maximum, unless otherwise indicated. The method of analysis for nitrogen shall be a matter of agreement between the purchaser and manufacturer.

For welded TP316, TP316N, TP316LN, and TP316H pipe, the nickel range shall be 10.0-14.0 %. For small diameter or thin walls or both, where many drawing passes are required, a carbon maximum of 0.040 % is necessary in grades TP304L and TP316L. Small diameter tubes are defined as those less 0.500 in (12.7mm) in outside diameter and light wall tubes as those less than 0.049 in (1.20 mm) in average wall thickness (1.10 mm) in minimum wall thickness

The titanium content shall be not less than five times the carbon content and not more than 0.70 %. The titanium content shall be not less than four times the carbon content and not more than 0.60 %. The Columbium plus titanium content shall be not less than ten times carbon content and not more than 1.00 %.

The Columbium plus titanium content shall be not less than eight times carbon content and not more than 1.00 %.

For welded pipe, the phosphorus maximum shall be 0.045 %. Grade S34751 shall have a columbium (Niobium) plus tantalum content of not less than 15 times the carbon content.

MECHANICAL PROPERTIES OF S.S.PIPES

Table-2 Annealing Requirements			A 312/A 312M	Table-3 Tensile Requirements		
Grade or UNS Designation	Solution Treating Temperature	Cooling Requirements	Grade	UNS Designation	Tensile Strength, min Ksi (MPa)	Yield Strength, Min Ksi (MPa)
All Grades not individually listed below	1900°F(1040°C)	rapid ^c	TP304L	S30403	70 (485)	25 (170)
TP321H, TP347H, TP348H			TP316L	S31603	70 (485)	25 (170)
Cold Rolled	2000°F (1100°C)		TP304	S30400	75 (515)	30 (205)
Hot Rolled only	1925°F (1050°C)		TP304H	S30409	75 (515)	30 (205)
TP304H, TP316H			TP309Cb	S30940	75 (515)	30 (205)
Cold Rolled	1900°F (1040°C)		TP309H	S30909	75 (515)	30 (205)
Hot rolled only	1900°F (1040°C)		TP309HCb	S30941	75 (515)	30 (205)
TP309H, TP309HCb, TP310H	1900°F (1040°C)		TP309S	S30908	75 (515)	30 (205)
TP310HCb			TP310Cb	S31040	75 (515)	30 (205)
S30815	1920°F (1050°C)	rapid	TP310H	S31009	75 (515)	30 (205)
S31272	1920°F (1050°C)	rapid	TP310HCb	S31041	75 (515)	30 (205)
S31254	2100°F (1150°C)	rapid	TP310S	S31008	75 (515)	30 (205)
S24565	2050-2140°F (1120-1170°C)	rapid		S31272	65 (450)	29 (200)
S35315	2010°F (1100°C)	rapid	TP316	S31600	75 (515)	30 (205)
N08367	2010°F (1100°C)	rapid	TP316H	S31609	75 (515)	30 (205)
N08904	2010°F (1100°C)	rapid	TP317	S31700	75 (515)	30 (205)
			TP317L	S31703	75 (515)	30 (205)
			TP321	S32100		
			Welded			
			Seamless		75 (515)	30 (205)
			≤ 3/8 in.		75 (515)	30 (205)
			> 3/8 in.		70 (485)	25 (170)
			TP321H	S32109		
			Welded		75 (515)	30 (205)
			Seamless			
			< 3/8 in.		75 (515)	30 (205)
			> 3/8 in.		70 (485)	25 (170)
			TP347	S34700	75 (515)	30 (205)
			TP347H	S3470	75 (515)	30 (205)
			TP347LN	S34751	75 (515)	30 (205)
			TP348	S34800	75 (515)	30 (205)
			TP348H	S34809	75 (515)	30 (205)
			TPXM-10	S21900	90 (620)	50 (345)
			TPXM-11	S21904	90 (620)	50 (345)
			TPXM-15	S38100	75 (515)	30 (205)
			TPXM-29	S24000	100 (690)	55 (380)
			TPXM-19	S20910	100 (690)	55 (380)
			TP304N	S30451	80 (550)	35 (240)
			TP316N	S31651	80 (550)	35 (240)
			TP304LN	S31653	75 (515)	30 (205)
			---	S31254	94 (650)	44 (300)
			---	S30615	90 (620)	40 (275)
			---	S30815	87 (600)	45 (310)
			---	S30600	78 (540)	35 (240)
			---	S31725	75 (515)	30 (205)
			---	S31726	80 (550)	35 (240)
			---	S31050		
			T<0.25 in.		84 (580)	39 (270)
			T>0.25 in.		78 (540)	37 (255)
			---	S32615	80 (550)	32 (220)
			---	S33228	73 (500)	27 (185)
			---	S24565	115 (795)	60 (415)
			---	S30415	87 (600)	42 (290)
			---	S32654	109 (750)	62 (430)
			---	S35315	94 (650)	39 (270)
			---	N08367:		
			t<0.187		100 (690)	45 (310)
			t>0.187		95 (655)	45 (310)
			---	N08904	71 (490)	31 (215)



STAINLESS STEEL PIPES & TUBES- CHEMICAL COMPOSITION & MECHANICAL PROPERTIES

ASTM Specifications	Grade	Scope	Chemical Composition %											Tensile Test				
			Production Process.		C	Mn	P	S	Si	Ni	Cr	Mo	Others	psi	Kg/mm ²	psi	Kg/mm ²	
			Steel	Tube														
A 268-62 T Seamless and Welded Ferritic Stainless Steel tubing for General Service	TP 405	General Corrosion resisting and high temperature service	Electric furnace	Seamless or welded	0.08 max	1.00 max	0.040 max	0.030 max	0.75 max	0.50 max	11.5~13.5	-	AlO.10 0.30	60000 min	42 min	30000 min	21 min	
	TP 410				0.15 max	1.00 max	0.040 max	0.030 max	0.75 max	0.50 max	11.5~13.5	-	-	60000 min		35000 min	25 min	
	TP 430				0.12 max	1.00 max	0.040 max	0.030 max	0.75 max	0.50 max	16.0~18.0	-	-	60000 min				
	TP 443				0.20 max	1.00 max	0.040 max	0.030 max	0.75 max	0.50 max	18.0~23.0	-	Cu 0.90-1.25	70000 min		47 min	40000 min	26 min
	TP 446				0.20 max	1.50 max	0.040 max	0.030 max	0.75 max	0.50 max	23.0~30.0	-	No 10-0.25	70000 min				
	TP 329				0.20 max	1.00 max	0.040 max	0.030 max	0.76 max	2.50 max	23.0~28.0	1.0-2.0	-	75000 min		53 min	45000 min	32 min
A 269-62 T Seamless and Welded Austenitic Stainless Steel tubing for General Service	TP 304	General Corrosion resisting and high temperature service	Electric furnace	Seamless or welded	0.08 max	2.00 max	0.040 max	0.030 max	0.75 max	8.0-11.0	18.0-20.0	-	-	75000 min	53 min	30000 min	21 min	
	TP 304L				0.035 max	2.00 max	0.040 max	0.030 max	0.75 max	8.00~13.00	18.00~20.00	-	-					
	TP 316				0.08 max	2.00 max	0.040 max	0.030 max	0.75 max	11.0~14.0	16.0~18.0	2.0-3.0	-					
	TP 316L				0.035 max	2.00 max	0.040 max	0.030 max	0.75 max	10.00~15.00	16.00~18.00	2.00-3.00	-					
	TP 317				0.08 max	2.00 max	0.040 max	0.030 max	0.75 max	11.0~14.0	18.0~20.0	3.0~4.00	-					
	TP 321				0.08 max	2.00 max	0.040 max	0.030 max	0.75 max	9.0~13.0	17.0~20.0	-	Ti 5 x C-0.60					
	TP 347				0.08 max	2.00 max	0.040 max	0.030 max	0.75 max	9.0~13.0	17.0~20.0	-	(Co+To)10 xC-1.0					
	TP 348				0.08 max	2.00 max	0.040 max	0.030 max	0.75 max	9.0~13.0	17.0~20.0	-	-					
A 269-62 T Seamless and Austenitic Chromium-Nickel Steel Tubes for Refinery Service	TP 304H	General Corrosion resisting and high temperature service	Electric furnace	Seamless or welded	0.04-0.10	2.00 max	0.040 max	0.030 max	0.75 max	8.0~11.0	18.0~20.0	-	-	75000 min	53 min	30000 min	21 min	
	TP 321				0.08 max	2.00 max	0.040 max	0.030 max	0.75 max	9.0~13.0	17.0~20.0	-	Ti 5xC-0.60					
	TP 321H				0.04-0.10	2.00 max	0.040 max	0.030 max	0.75 max	9.0~13.0	17.0~20.0	-	Ti 4 x C 0.60					
	TP 347				0.08 max	2.00 max	0.040 max	0.030 max	0.75 max	9.0~13.0	17.0~20.0	-	(Co+To) 8 XC-1.0					
	TP 347H				0.04-0.10	2.00 max	0.040 max	0.030 max	0.75 max	9.0~13.0	17.0~20.0	-	(Co+To) 10 XC-1.0					
A 334-62 T Seamless hand Welded Carbon and Alloy-Steel I Tubes for low Temperature Service (1)	0	Carbon and alloy steel tubes for low temperature service	Open hearth or Electric furnace	Seamless or automatic welding process with no addition of filler metal in the welding operation	0.25 max	0.64-1.06	0.050 max	0.060 max	-	-	-	-	-	55000 min	39 min	30000 min	21 min	
	3				0.19 max	0.31-0.64	0.050 max	0.050 max	0.18~0.37	3.18~3.82	-	-	-	55000 min	39 min	30000 min	21 min	
	5				0.19 max	0.20-0.64	0.050 max	0.050 max	0.18~0.37	4.68~5.32	-	-	-	65000 min	46 min	35000 min	25 min	

STAINLESS STEEL PIPES & TUBES- CHEMICAL COMPOSITION & MECHANICAL PROPERTIES

Elongation (in 2 in %)		Flattening Test	Flaring Test		Hardness Test		Hydrostatic Test	Impact Test				
								Impact Temp.	Impact Requirement			
									Min. impact test temp. deg-fahrt	Size of specimen mm	Min. average notched bar impact value of each set of three specimen ft-1b	Min. notched bar impact value of one specimen only of a set ft - 1b
5/16 in & over in wall thickness	Standard round 2 in gauge length test specimen		d/D	d1 (min)	Brinell T T>0.200 (5.0mm)	Rockwell 0.200 in (15.0 mm)> t > 0.65 (1.7 mm)	Test Pressure psi (kg/cm ²)					
20 min				1.10d	207 max	B 95 max	1000 (70) min 30000 (2110) x 1/D max	-	-	-	-	
18 min	-				207 max	B 95 max						
10 min	-				190 max	B 90 max						
					207 max	B 95 max						
					207 max	B 95 max						
					241 max	B 100max						
			0.9	1.21 d								
			0.8	1.22 d								
			0.7	1.25 d								
			0.6	1.30 d	200 max	B 90 max	1000 (70) min 30000(2110) x 1/D max	-	-	-	-	
			0.5	1.39 d								
			0.4	1.51 d								
			0.3	1.68 d								
35 min			0.9	1.21 d								
			0.8	1.22 d								
			0.7	1.25 d	200 max		30000(2110) x 1/D d 3 IN (76.2 MM) 2500 (176) d 3 IN (76.2 MM) 4500 (316)	M A X				
			0.6	1.30 d								
			0.5	1.39 d								
			0.4	1.51 d								
			0.3	1.68 d								
35 min	28 min	Medium carbon steel 1.07 t H= $\frac{0.07 + f/D}{1.08 t}$ Ferritic alloy steel	0.9	Carbon Other moly ferritic bodenum alloy and austenitic steel	163 max	B 85 max		- 50				
			0.8									
			0.7									
			0.6	1.21 d 1.15 d 1.22 d 1.17 d	190 max	B 90 max	13200 (2250) x 1/D D 1 in (25.4 mm) 1000 (70) D 1 1/2 in (38.1 mm) 1500 (105) S 2 in (50.8) 2000 (141) D 3 in (76.2 mm) 2500 (176) D 5 in (127.0mm) 3500 (246) D 5 in (127.0 mm) 4500 (316)	M A X	- 150	10 by 10 10 by 7.5	15 12.5	10 9.5
			0.5	1.25 d 1.19 d 1.30 d 1.23 d	207 max	B 95 max				10 by 5	10	7.0
30 min	22 min	Austenitic steel and 10W carbon steel 1.09f H= $\frac{0.09+f/D}{1.09f}$	0.4	1.39 d 1.28 d 1.51 d 1.38 d				- 150		10 by 2.5	5	3.5
			0.3	1.68 d 1.50 d								

STAINLESS STEEL PIPES & TUBES- CHEMICAL COMPOSITION & MECHANICAL PROPERTIES

ASTM Specification	Grade	Scope	Production Process		Chemical Composition %									
					C	Mn	P	S	Si	Cr	Mo	Ni	Others	
			Steel	Tube										
A 209-62T Seamless Molybdenum Alloy Steel Boiler and Superheater Tubes	T 1	Boiler and superheater tubes.	Open-hearth or electric furnace	Seamless (Hot-finished or cold drawn, as specified)	0.10~0.20	0.30~0.80	0.025~max	0.025~max	0.10~0.50	-	0.44~0.65	-	-	
	T 1a				0.15~0.25	0.30~0.80	0.025~max	0.025~max	0.10~0.50	-	0.44~0.65	-	-	
	T 1b	Superheater tubes.			0.14~max	0.30~0.80	0.025~max	0.025~max	0.10~0.50	-	0.44~0.65	-	-	
A 210-62T Seamless Medium Carbon Steel Boiler and Superheater Tubes		Boiler tubes and boiler flues (safe ends, arch and stay tubes and superheater tubes.	Open-hearth or electric furnace	Seamless (Hot-finished or cold drawn, as specified)	0.27~max	0.93~max	0.035~max	0.035~max	0.10~min	-	-	-	-	
(1) A 213-62T Seamless Medium And Austenitic Alloy steel Boiler, Superheater and Heat-Exchanger Tubes	Ferritic steel.	T 2			0.10~0.20	0.30~0.61	0.025~max	0.025~max	0.10~0.30	0.50~0.81	0.44~0.65	-	-	
		T 3b			0.15~max	0.30~0.60	0.030~max	0.030~max	0.50~max	1.65~6.00	0.44~0.65	-	-	
		T 5			0.15~max	0.30~0.60	0.025~max	0.025~max	0.50~max	4.00~6.00	0.45~0.65	-	-	
		T 5b			0.15~max	0.30~0.60	0.025~max	0.025~max	1.00~2.00	4.00~6.00	0.45~0.65	-	-	
		T 5c			0.12~max	0.30~0.60	0.025~max	0.025~max	0.50~max	4.00~6.00	0.45~0.65	-	Ti 4 x C -0.78	
		T 7			0.15~max	0.30~0.60	0.03~max	0.03~max	0.50~1.00	6.00~8.00	0.45~0.65	-	-	
		T 9			0.15~max	0.30~0.60	0.025~max	0.025~max	0.25~1.00	8.00~10.00	0.90~1.10	-	-	
		T 11			0.15~max	0.30~0.60	0.025~max	0.025~max	0.50~1.00	1.00~1.50	0.44~0.65	-	-	
		T 12			0.15~max	0.30~0.61	0.025~max	0.025~max	0.50~max	0.80~1.25	0.44~0.65	-	-	
	T 17			0.15~0.25	0.30~0.61	0.025~max	0.025~max	0.15~0.35	0.80~1.25	-	-	Ve 0.15-min		
	Austenitic Steel	T 21	Boiler and Superheater tubes and heat exchanger tubes	Electric-furnace or other processes approved by the purchaser, except that Grades. T12 and T 17 may be made by the open-hearth process	Seamless (Hot-finished or cold drawn, as specified)	0.15~max	0.30~0.60	0.025~max	0.025~max	0.50~max	2.65~3.35	0.80~1.06	-	-
		TP 22				0.15~max	0.30~0.60	0.025~max	0.025~max	0.50~max	1.90~2.60	0.87~1.13	-	-
		TP 304				0.08~max	2.00~max	0.040~max	0.030~max	0.75~max	18.0~20.0	-	8.00~11.0	-
		TP 304H				0.04~0.10	2.00~max	0.040~max	0.030~max	0.75~max	18.0~20.0	-	8.00~11.0	-
		TP 304L				0.035~max	2.00~max	0.040~max	0.030~max	0.75~max	18.0~20.0	-	8.00~13.0	-
		TP 310				0.15~max	2.00~max	0.040~max	0.030~max	0.75~max	24.0~26.0	-	19.0~22.0	-
		TP 316				0.08~max	2.00~max	0.040~max	0.030~max	0.75~max	16.0~18.0	2.00~3.00	11.0~14.0	-
		TP 316H				0.04~0.10	2.00~max	0.040~max	0.030~max	0.75~max	16.0~18.0	2.00~3.00	11.0~14.0	-
		TP 316L				0.035~max	2.00~max	0.040~max	0.030~max	0.75~max	16.0~18.0	2.00~3.00	10.0~15.0	-
		TP 321				0.08~max	2.00~max	0.040~max	0.030~max	0.75~max	17.0~20.0	-	9.0~13.0	Ti 5 x C -0.60
		TP 321H				0.04~0.10	2.00~max	0.040~max	0.030~max	0.75~max	17.0~20.0	-	9.0~13.0	Ti 5 x C -0.60
TP 347					0.08~max	2.00~max	0.040~max	0.030~max	0.75~max	17.0~20.0	-	9.0~13.0	(Co+Ta) 10 XC-1.00	
TP 347H				0.04~0.10	2.00~max	0.040~max	0.030~max	0.75~max	17.0~20.0	-	9.0~13.0	(Co +Ta) 8 XC-1.00		
TP 348				0.08~max	2.00~max	0.040~max	0.030~max	0.75~max	17.0~20.0	-	9.0~13.0	(Co+Ta)10 XC-1.00 TA0.10max		
TP 348H				0.04~0.10	2.00~max	0.040~max	0.030~max	0.75~max	17.0~20.0	-	9.0~13.0	(Co+Ta)8 XC-1.00 Ta0.10max		

STAINLESS STEEL PIPES & TUBES- CHEMICAL COMPOSITION & MECHANICAL PROPERTIES

Tension Test						Flattening Test	Elongation Test				Flaring Test		Hardness Test				Hydrostatic Test
Tensile Strength		Yield Point		Elongation (in 2)%									Brinell ≥0.200 in (5.0 mm)		Rockwell 0.200 in (0.0mm) ≥ ≤0.065(1.7mm)		Test Pressure psi (Kg/cm ²)
Psi	Kg/ mm ²	Psi	Kg/ mm ²	5/6 in and over in wall thickness	Standard round 2 in gauge length test speciman		D ≤3/4	D ≤2 1/2	D ≤3 3/4	D ≥3 3/4	d/D	d' (min)	Hot rolled tubes	Cold drawn tubes	Hot rolled tubes	Cold drawn tubes	
							in(19.0 mm)	in(63.5 mm)	in(95.2 mm)	in(95.2 mm)							
55000 min	39 min	30000 min	21 min	30 min		1.081 $H = \frac{0.08+1/D}{}$								137 max	B 77max	32000 (2250)xt/D D< t in (25.4 mm) 1000 (70) D< 11/2 in (25.4 mm) 1500 (105) D< 2 in (50.8 mm) 2000 (141) D< 3 in (76.2 mm) 2500 (176) D< 5 in (127.0 mm) 3500 (246) D< 5 in (127.0 mm) 4500 (316)	
53000 min	42 min	28000 min	22 min	30 min	-						0.9	1.21 d					
60000 min	37 min	32000 min	20 min	30 min							0.8	1.22 d					
										0.7	1.25 d						
										0.6	1.30 d						
										0.5	1.39 d						
										0.4	1.51 d						
										0.3	1.68 d						
60000 min	42 min	37000 min	26 min	25 min	-	1.071 $H = \frac{0.07+1/D}{}$								143 max	B 77 max	32000 (2250)xt/D D< t in (25.4 mm) 1000 (70) D< 11/2 in (38.1 mm) 1500 (105) D< 2 in (50.8 mm) 2000 (141) D< 3 in (76.2 mm) 2500 (176) D< 5 in (127.0 mm) 3500 (246) D< 5 in (127.0 mm) 4500 (316)	
											0.9	1.21 d					
											0.8	1.22 d					
										0.7	1.25 d						
										0.6	1.30 d						
										0.5	1.39 d						
										0.4	1.51 d						
										0.3	1.68 d						
										0.9	1.15d	163 max	8.79 max				
										0.9	1.15d	163 max	B 85 max				
										0.8	1.17d	163 max	B 85 max				
										0.8	1.17d	163 max	B 85 max				
										0.7	1.19d	179 max	B 89 max				
										0.7	1.19d	163 max	B 85 max				
										0.6	1.23d	179 max	B 89 max				
										0.6	1.23d	163 max	B 85 max				
										0.5	1.28d	163 max	B 85 max				
										0.5	1.28d	163 max	B 85 max				
										0.4	1.38d	163 max	B 85 max				
										0.4	1.38d	163 max	B 85 max				
										0.3	1.50d	163 max	B 85 max				
										0.9	1.21d						
75000 min	53 min	30000 min	21 min			1.091 $H = \frac{0.09=1/D}{}$											
70000 min	49 min	25000 min	18 min								0.8	1.22d					
											0.7	1.25d					
75000 min	53 min	30000 min	21 min								0.6	1.30d	190 max	B 90 max			
70000 min	49 min	25000 min	18 min	35 min							0.5	1.39d					
											0.4	1.51d					
											0.3	1.68d					

STEEL GRADES

STAINLESS STEEL EQUIVALENT SPECIFICATIONS FOR CHEMICAL

Designation Sandvik	Chemical composition (nominal), %			Mo	Others	Standards* UNS	ASTM TP AISI
	C	Cr	Ni				
5R 10	<0.05	18.5	9	-	-	S30400/S30409	304/304H
SANMAC 304L	<0.030	18.5	10.5	-	-	S30400/S30403	304/304L
3 R12	<0.030	18.5	10	-	-	S30403	304L
3 R 19	<0.03	18.5	9.5	-	N	S30453	304LN
5R60	<0.05	17	12	2.6	-	S31600/S31609	316H/316H
SANMAC 316 L	<0.030	17	13	2.6	-	S31600/S31603	316/316L
3R60	<0.030	17.5	13	2.6	-	S31603	316L
3R64	<0.03	18.5	14.5	3.1	-	S31703	317L
3R65	<0.030	17	11.5	2.1	-	S31603	316L
6R35	<0.06	17.9	10.3	-	Ti	S32100/ S32109	321/ 321H
8R30	<0.08	17.5	10	-	Ti	S32100/ S32109	321/ 321H
8R40	<0.06	17.5	11	-	Nb	S34700/ S34709	347/ 347H
8R41	0.06	16.5	13	-	Nb	-	-
5R75	<0.05	17	12	2.1	Ti	(S31635)	(316Ti)
8R70	<0.08	17	13	2.1	Ti	(S31335)	(316Ti)
3R60 U.G	<0.020	17.5	14	2.6	-	S31603	316L (U.G)
3R69	<0.030	17.5	13.5	2.6	N	(S31653)	(316LN)
2RE10	<0.020	24.5	20.5	-	-	-	(310L)
2RE69	<0.020	25	22	2.1	N	S31050	310 mod.
2RE69	<0.020	25	22	2.1	N	-	(310 mod.)
3RE60	<0.030	18.5	4.9	2.7	Si, N	S31500	-
SAF2304	<0.030	23	4.5	-	N	S32304	-
SAF2205	<0.030	22	5.5	3.2	N	S31803	-
SAF2507	<0.030	25	7	4	N	S32750	-
2RK65	<0.02	20	25	4.5	Cu	N08904	-
254 SMO	<0.020	20	18	6.1	N Cu	S31254	-
Sanicro 28	<0.020	27	31	3.5	Cu	N08028	-
4C54	<0.20	26.5	-	-	N	S44600	446-1
8RE10	0.07	24.5	20.5	-	-	S31008	310S
253 MA	0.08	21	11	-	Si, N, Ce	S30815	-
Sanicro 31HT	0.07	21	31	-	Ti, Al	N08811/ N08810	-
Sanicro 30	<0.030	20	32	-	Ti, Al	N08800	Alloy 800
Sanicro 41	<0.030	21.5	40	3	Cu, Ti	N08825	Alloy 825
Sanicro 69	<0.05	30.0	60.0	-	Fe	N06690	Alloy 690
Sanicro 70	<0.08	16	72.5	-	Fe	N06600	Alloy 600
10 RE51	0.04	26	5	1.4	-	S32900	--
5RA50	<0.050	18	9.5	0.5	S	S30300	303

1) Valid for SEW 470
2) DIN 17459

3) Sanicro 31 H
4) Valid for SEW 400

5) NFA 49-317 with min 45% can be fulfilled
6) Is replacing 8R30 in our stock standard programme
7) Is replacing 8R70 in our stock standard programme

Designation of Grades according to EN is pending
In brackets, nearest equivalent steel grade.

Other steel grades may be produced on request.

Sandvik, SAF 2304, SAF 2205, SAF 2507, Sanicro and SANMAC are trademarks owned by Sandvik AB
253 MA and 254 SMO are trademarks owned by Avesta Sheffield AB.

STAINLESS STEEL EQUIVALENT SPECIFICATIONS FOR MECHANICAL

BS	SS	Werkstoff-Nr.	AFNOR	Mechanical strength Proof strength R _{p0.2} MPa, min	Tensile strength, R _m MPa	Elongation A %, min
304S31/51 304S11/304S31 304S11 - 316S33 316S13/16S33 316S13 - 316S11	2333 2352/2333 2352 2371 2343 2353/2343 2353 2367 2348	1.4301 1.4306/1.4301 1.4306 1.4311 1.4436/(1.4401) 1.4435/1.4436 1.4435/(1.4404) (1.4438) 1.4404/1.4401	Z6CN 18-09 Z2CN 18-10/Z6CN18-09 Z2CN18-10 Z2CN18-10AZ Z6CND17-12 Z2CND17-13/Z6CND17-12 Z2CND17-13 Z2CND19-15 Z2CND17-12/ (Z6CND17-11)	210 210 210 275 220 220 220 220 220	515-690 515-680 515-680 550-750 515-690 515-690 515-690 515-690 515-690	45 40 ⁵⁾ 45 40 40 40 ⁵⁾ 45 40 45
321S31/51 321S31/51 347S31/51 - - -	2337 2337 2338 - 2350 2350	1.4541/1.4878 ¹⁾ 1.4541/1.4878 ¹⁾ 1.4550 1.4961 1.4571 1.4571	- - (Z6CNNb18-10) - (Z6CNDT17-12) (Z6CNDT17-12)	210 210 210 210 210(190) 210(190)	515-690 515-690 515-690 510-690 500-730 500-730	35 35 35 35 35 35
316S13 - - - -	2353 (2375) - - -	1.4435 1.4429 1.4335 1.4466 1.4465	(Z2CND17-12) Z2CNS17-12AZ Z2CN25-20 Z1CND25-22AZ -	190 300 210 270 255	490-690 590-780 500-670 580-780 540-740	40 40 35 30 40
- - - -	2376 2327 2377 2328	1.4417 1.4362 1.4462 -	Z2CND18-05-03 Z2CN23-04AZ Z2CND22-05.03 -	450 400 450 550	700-880 600-820 680-880 800-1000	30 25 25 25
- - -	2562 2378 2584	1.4539 (1.4529) 1.4563	Z1NCDU25-20-04 Z1CNDU20-18-06AZ Z1NCDU31-27-03	220 300 215	520-720 ≥650 550-750	35 35 40
- - - NA15	2322 2361 2368 -	1.4749 1.4845 1.4893 1.4959 ²⁾ /1.4876 ¹⁾ 1.4958 ³⁾	- Z12CN25-20 - -	275 210 310 170	500-700 515-750 600-850 450-700	20 35 40 35
NA15 - - NA14	- - - -	1.4558 2.4858 - 2.4816	- - - -	205 240 240 245	520-690 590-750 ≥585 550-750	30 30 30 30
- -	2324 2346	1.4460 ⁴⁾ 1.4305	- Z10CNF18-09	485 215	620-800 500-700	20 45

**ASA PIPE SCHEDULES
WALL = WALL THICKNESS IN MILLI METER**

CARBON STEEL SEAMLESS PIPE DIMENSIONS & WEIGHT

WT = WEIGHT IN KG PER METER

Nominal Pipe size Inches	O D mm	Schedule 10		Schedule 20		Schedule 30		Standard		Schedule 40		Schedule 60		Extra Strong		Schedule 80		Schedule 100		Schedule 120		Schedule 140		Schedule 160		Schedule Extra Strong				
		Wall	Wt.	Wall	Wt.	Wall	Wt.	Wall	Wt.	Wall	Wt.	Wall	Wt.	Wall	Wt.	Wall	Wt.	Wall	Wt.	Wall	Wt.	Wall	Wt.	Wall	Wt.	Wall	Wt.	Wall	Wt.	
1/8	10.3							1.7	0.357	1.7	0.357			2.4	0.470	2.4	0.470													
1/4	13.7							2.2	0.625	2.2	0.625			3.0	0.804	3.0	0.804													
3/8	17.1							2.3	0.848	2.3	0.804			3.2	1.10	3.2	1.10													
1/2	21.3							2.8	1.26	2.8	1.26			3.7	1.62	3.7	1.62							4.6	1.96	7.5	2.54			
3/4	26.7							2.9	1.68	2.9	1.68			3.9	2.19	3.9	5.5							4.8	2.89	7.5	3.63			
1	33.4							3.4	2.50	3.4	2.50			4.5	3.23	4.5	3.23							6.4	4.23	9.1	5.45			
1 1/4	42.2							3.6	3.38	3.6	3.38			4.9	4.46	4.9	4.46							6.4	5.60	9.7	7.75			
1 1/2	48.3							3.7	4.05	3.7	4.05			5.1	5.40									7.1	7.23	10.2	9.54			
2	60.3							3.9	5.43	3.9	5.43			5.5	7.47	5.5	7.47							8.7	11.1	11.1	13.4			
2 1/2	73.0							5.2	8.62	5.2	8.62			7.0	11.4	7.0	11.4							9.5	14.9	14.0	20.4			
3	88.9							5.5	11.3	5.5	11.3			7.6	15.3	7.6	15.3							11.3	21.3	15.2	27.2			
3 1/2	101.6							5.7	13.6	5.7	13.6			8.1	18.6	8.1	18.6									16.2	34.0			
4	114.3							6.0	16.1	6.0	16.1			8.6	22.3	8.6	22.3			11.1	28.3			13.5	33.5	17.1	41.1			
5	141.3							6.6	21.8	6.6	21.8			9.5	30.9	9.5	30.9			12.7	40.2			15.9	49.0	19.0	57.4			
6	168.3							7.1	28.2	7.1	28.2			11.0	42.5	11.0	42.5			14.3	54.2			18.3	67.5	21.9	79.1			
8	219			6.4	33.3	7.0	36.7	8.2	42.5	8.2	42.5	10.3	53.1	12.7	64.6	12.7	64.6	15.1	75.8	18.3	90.7	20.6	101	23.0	112.0	22.2	108.0			
10	273.0			6.4	41.7	7.8	50.9	9.3	60.2	12.7	81.5	12.7	81.5	12.7	81.5	15.1	95.8	18.3	115.0	21.4	133.0	25.4	155	28.6	172.0	25.4	155.0			
12	323.9			6.4	49.7	8.4	65.1	9.5	73.8	10.3	79.7	14.3	109.0	12.7	97.4	17.4	132.0	21.4	160.0	25.4	187.0	28.6	208	33.3	239.0	25.4	187.0			
14	355.6	6.4	54.6	7.9	68.1	9.5	81.2	9.5	81.2	11.1	94.3	15.1	126.0	12.7	107.0	19.0	158.0	23.8	195.0	27.8	224	31.8	253	35.7	281.0					
16	406.4	6.4	62.6	7.9	77.9	9.5	93.1	9.5	81.2	11.1	94.3	15.1	126.0	12.7	123.0	21.4	203.0	26.2	245.0	30.9	286.0	36.5	333	40.5	365.0					
18	457.2	6.4	70.5	7.9	87.8	11.1	122.0	9.5	105.0	14.3	156.0	19.0	206.0	12.7	139.0	23.8	254.0	29.4	310.0	34.9	363.0	39.7	408	45.2	459.0					
20	508.0	6.4	78.5	9.5	117.0	12.7	155.0	9.5	117.0	15.1	183.0	20.6	248.0	12.7	155.0	26.2	311.0	32.5	381.0	38.1	441.0	44.4	508	50.0	564.0					
22	558.8	6.4	86.4	9.5	129.0	12.7	171.0	9.5	129.0			22.2	294.0	12.7	171.0	28.6	373.0	34.9	451.0	41.3	526.0	47.6	6000	54.0	671.0					
24	609.6	6.4	94.7	9.5	141.0	14.3	210.0	9.5	141.0	17.4	255.0	24.6	355.0	12.7	187.0	30.9	441.0	38.9	547.0	45.00	639.0	52.4	719.0	59.5	807.0					
26	660.4	7.9	128.0	12.7	203.0			9.5	153.0					12.7	203.0															
28	711.2	7.9	138.0	12.7	219.0	15.9	272.0	9.5	165.0					12.7	219.0															
30	762.0	7.9	147.0	12.7	234.0	15.9	292.0	9.5	176.0					12.7	234.0															
32	812.8	7.9	157.0	12.7	250.0	15.9	312	9.5	188.0					12.7	250.0															
34	863.6	7.9	167.0	12.7	266.0	15.9	332.0	9.5	200.0					12.7	266.0															
36	914.4	7.9	177.0	12.7	282.0	15.9	351.0	9.5	212.0					12.7	281.0															

CARBON STEEL, ALLOY STEEL LOW TEM, PIPE AND TUBE SPECIFICATION

CHEMICAL									MECHANICAL PROPERTIES			SPECIFIC REQUIREMENT
									TENSILE STRENGTH	YIELD STRESS	ELONGATION	
SPECIFICATION	WT	C%	Mn %	P % MAX	S% MAX	Si%	Cr%	Mo%	Mpa	Mpa	50mm MIN Longitudinal	
ASTM A53/A ASTM A53/B ASTM /A 106/A ASTM A 106/B ASTM A 106/C	AW AW AW AW AW	0.25MAX 0.30MAX 0.25MAX 0.35MAX 0.35MAX	0.95MAX 1.20MAX 0.27-0.93 0.29-1.06 0.29-1.06	0.050 0.050 0.035 0.035 0.035	0.045 0.045 0.025 0.035 0.035	- - 0.10MIN 0.10MIN 0.10MIN	- - 0.40MAX 0.40MAX 0.40MAX	- - 0.15MAX 0.15MAX 0.15MAX	330MIN 415MIN 330MIN 415 MIN 485MIN	205MIN 240MIIN 205MIN 240MIN 275MIN	36 29/5 35/2 30/22 30/22	Cr Mo Cu Ni Va 40 15 40 40 08 Five elements not to exceed 1%
ASTM A179 ASTMA214 ASTM A192 ASTM a209/T1 ASTM A209/T1a ASTM A209/T1b ASTM A210/A-1 ASTMA210/C	MW MW MW MW MW MW MW MW	0.06-018 0.18MAX 0.06-0.18 0.10-0.20 0.15-0.25 0.14MAX 0.27max 0.35MAX	0.27-0.63 0.27-0.63 0.27-0.63 0.30-0.80 0.30-0.80 0.30-0.80 0.93max 0.23-1.06	0.035 0.035 0.035 0.025 0.025 0.025 0.035 0.035	0.035 0.035 0.035 0.025 0.025 0.025 0.035 0.035	- - 0.25MAX 0.10-0.50 0.10-0.50 0.10MIN 0.10min 0.10MIN	- - - - - - - -	- - - 0.44-0.65 0.44-0.65 0.44-0.65 - -	325MIN 385MIN 325MIN 380MIN 365MIN 415MIN 415MIN 485MIN	180MIN 180MIN 180MIN 205MIN 195MIN 220MIN 255MIN 275MIN	35.0 35.0 35.0 30/22 30/22 30/22 30/22 30/22	Hardness 72 HRB Max Hardness 72 HRB Max Hardness 77 HRB Max Hardness 80 HRB Max Hardness 81 HRB Max Hardness 77 HRB Max Hardness 79 HRB Max Hardness 89 HRB Max
ASTM A213/T2 ASTM A213/T5 ASTM A213/T11 ASTM A213/T12 ASTM A213/T22	MW MW MW 0.05 0.05	0.10/0.20 0.15MAX 0.15MAX 0.15MAX 0.15MAX	0.30-0.61 0.30-0.60 0.30-0.60 0.30-0.61 0.30-0.60	0.025 0.025 0.025 0.025 0.025	0.025 0.025 0.025 0.025 0.025	0.10-0.30 0.50MAX 0.50MAX 0.50MAX 0.50MAX	0.50-0.81 4.00-6.00 1.00-1.50 0.80-1.25 1.90-2.60	0.44-0.65 0.44-0.65 0.44-0.65 0.44-0.65 0.87-1.13	415MIN 415MIN 415MIN 415MIN 415MIN	205MIN 205MIN 205MIN 220MIN 205MIN	30/22 30/22 30/22 30/22 30/22	Hardness 85 HRB Max Hardness 85 HRB Max Hardness 85 HRB Max Hardness 85 HRB Max Hardness 85 HRB Max
ASTM A333/3 ASTM A333/6 ASTM A334/3 ASTM A334/6	AW AW AW MW	0.19MAX 0.30MAX 0.19MAX 0.30MAX	0.31-0.64 0.29-1.06 0.31-0.64 0.9-1.06	0.025 0.025 0.025 0.025	0.025 0.025 0.025 0.025	0.18-0.37 0.10MIN 0.18-0.37 0.10MIN	Ni -- Ni -	3.18-3.82 - 3.18-3.82 -	380MIN 415MIN 380MIN 415MIN	205MIN 240MIN 205MIN 240MIN	35/25 30/22 35/28 30/22	IMPACT AS -50f FOR 40X10/18/1490 HRB MAX 50 f 40X10/18/14
ASTM A335/P1 ASTM A335/P2 ASTM A335/P5 ASTM A335/P11 ASTM A335/P12 ASTM A335/P22	AW AW AW 0.05 0.05 0.05	0.10-0.20 0.10-0.20 0.15MAX 0.15MAX 0.15MAX 0.15MAX	0.30-0.80 0.30-0.61 0.30-0.60 0.30-0.60 0.30-0.61 0.30-0.60	0.025 0.025 0.025 0.025 0.025 0.025	0.025 0.025 0.025 0.025 0.025 0.025	0.10-0.50- 0.10-0.30 0.50-1.00 0.50-1.00 0.50MAX 0.50MAX	- 0.50-0.81 4.00-6.00 1.00-1.50 0.80-1.25 1.90-2.60	0.40-0.65 0.40-0.65 0.40-0.65 0.40-0.65 0.40-0.65 0.87.1.13	380MIN 380MIN 415MIN 415MIN 415MIN 415MIN	205MIN 205MIN 205MIN 205MIN 205MIN 205MIN	30/22 30/22 30/22 30/22 50/22 30/22	
BS/3059/1/33 BS/3059/2/33 BS/3059/245		0.15Max 0.15MAX 0.120.18	0.30-0.70 0.400.70 0.90-1.20	0.050 0.050 0.035	0.050 0.050 0.035	- 0.10-0.35 0.10-0.35	- - -	- - -	324-441 324-441 441-560	186MIN 186MIN 245MIN	25 21 22	
BS/3059/2/620 DIN/17175/ST35.8 DIN/17175/ST45.8 DIN/17175/15MO3 DIN/17175/13CrMo44 DIN/17175/10CrM910		0.10-0.15 0.17MAX 0.22MAX 0.12-0.20 0.10-0.18 0.15MAX	0.40-0.70 0.40MIN 0.45MIN 0.50-0.80 0.40-0.60 0.40-0.60	0.040 0.040 0.040 0.040 0.040 0.040	0.040 0.040 0.040 0.040 0.040 0.040	0.10-0.35 0.35MAX 0.10-0.35 0.10-0.35 0.15-0.35 0.15-0.50	0.70-1.10 - - - 0.70-1.60 2.0-2.5	0.45-0.65 - - 0.250-0.35 0.40-0.50 0.9-1.10	441-618 340-441 441-540 441-540 441-570 441-570	235MIN 235MIN 255 MIN 284MIN 294MIN 249MIN	22 25 25 21 22 22	
ASTM A199/T5 ASTM A199/T11 ASTM A199/T22 ASTM A199/T4 ASTM A199/T7 ASTM A199/T5 ASTM A199/T11 ASTMA199/T22 ASTM A199/T4 ASTM A199/T7 ASTM A199/T9 ASTM A199/T9 ASTM A199/T9 ASTM A335/P9 ASTM A178A ASTM A178C ASTM A178B	MW MW MW MW MW MW MW MW MW MW MW MW MW MW MW MW MW	0.15MAX 0.05-0.15 0.05-0.15 0.15MAX 0.15MAX 0.15MAX 0.05-0.15 0.05-0.15 0.05-0.15 0.15MAX 0.15MAX 0.15MAX 0.15MAX 0.06-0.18 0.35 MAX 0.27MAX	0.30-0.60 0.30-0.60 0.30-0.60 0.30-0.60 0.30-0.60 0.30-0.60 0.30-0.60 0.30-0.60 0.30-0.60 0.30-0.60 0.30-0.60 0.30-0.60 0.30-0.60 0.30-0.60 0.27-0.63 0.80 MAX	0.025 0.025 0.025 0.025 0.025 0.025 0.025 0.025 0.025 0.025 0.025 0.025 0.025 0.035 0.035 0.030	0.025 0.025 0.025 0.025 0.025 0.025 0.025 0.025 0.025 0.025 0.025 0.025 0.025 0.035 0.035 0.015	0.50MAX 0.50-1.00 0.50MAX 0.50-1.00 0.50-1.00 0.50MAX 0.25-1.00 0.25-1.00 0.25-1.00 0.25-1.00 0.25-1.00 0.25-1.00 0.25-1.00 0.25-1.00 0.10MIN	4.00-6.00 1.00-1.50 1.90-2.60 2.15-2.85 6.00-8.00 4.00-6.00 1.00-1.50 1.90-2.60 2.15-2.852 6.00-8.00 8.00-10.00 8.00-10.00 8.00-10.00 8.00-10.00 8.00-10.00 -	0.45-0.65 0.44-0.65 0.87-1.13 0.44-0.65 0.45-0.65 0.45-0.65 0.44-0.65 0.44-0.85 0.45-0.65 0.90-1.10 0.90-1.10 0.90-1.10 0.90-1.10 0.09-1.10 - - -	415MIN 415MIN 415MIN 415MIN 415MIN 415MIN 415MIN 415MIN 415MIN 415MIN 415MIN 415MIN 415MIN 325MIN 415MIN 485MIN	170MIN 170MIN 170MIN 170MIN 170MIN 170MIN 170MIN 170MIN 170MIN 170MIN 170MIN 170MIN 170MIN 180MIN 170MIN 275MIN	30/22 30/22 30/22 30/22 30/22 30/22 30/22 30/22 30/22 30/22 30/22 30/22 30/22 35 30 30	HARDNESS 85 HRB MAX HARDNESS 85 HRB MAX HARDNESS 85 HRB MAX HARDNESS 85 HRB MAX HARDNESS 85 HRB MAX HARDNESS 85 HRB MAX HARDNESS 85 HRB MAX HARDNESS 85 HRB MAX HARDNESS 85 HRB MAX HARDNESS 85 HRB MAX HARDNESS 85 HRB MAX HARDNESS 85 HRB MAX HARDNESS 85 HRB MAX HARDNESS 85 HRB MAX HARDNESS 85 HRB MAX HARDNESS 85 HRB MAX

TABLE 1 STAINLESS STEEL PLATES - CHEMICAL COMPOSITION

UNS Designation ^B	Type ^C	Carbon ^D	Manganese	Phosphorus	Sulphur	Silicon	Chromium	Nickel	Molybdenum	Nitrogen	Copper	Other Elements ^{E,F}
Austenitic (Chromium-Nickel)(Chromium-Manganese-Nickel)												
N08020	...	0.07	2.00	0.045	0.035	1.00	19.0-21.0	32.0-38.0	2.00-3.00	...	3.0-4.0	Cb 8xc min, 1.00 max
N08367	...	0.030	2.00	0.040	0.030	1.00	20.0-22.0	23.5-25.5	6.0-7.0	0.18-0.25	0.75	Fe ^H 39.5 min
N08800	800 ^G	0.010	1.50	0.0045	0.015	1.00	19.0-23.0	30.0-35.0	0.75	Al 0.15-0.60
N08810	800H ^G	0.05-0.10	1.50	0.045	0.015	1.00	19.0-23.0	30.0-35.0	0.75	Ti 0.15-0.60
N08811	...	0.06-0.10	1.50	0.040	0.015	1.00	19.0-23.0	30.0-35.0	0.75	Fe ^H 39.5 min
N08904	904L ^G	0.020	2.00	0.045	0.030	1.00	19.0-23.0	23.0-28.0	4.0-5.0	0.10	1.0-2.0	Al 0.15-0.60
N08926	...	0.020	2.00	0.030	0.010	0.50	19.0-21.0	24.0-26.0	6.0-7.0	0.15-0.25	0.5-1.5	Ti 0.15-0.60
S20100	201	0.15	5.5-7.5	0.060	0.030	1.00	16.0-18.0	3.5-5.5	...	0.25
S20103	...	0.03	5.5-7.5	0.045	0.030	0.75	16.0-18.0	3.5-5.5	...	0.25
S20153	...	0.03	6.4-7.5	0.045	0.015	0.75	16.0-17.5	4.0-5.0	...	0.10-0.25	1.00	...
S20161	...	0.15	4.0-6.0	0.040	0.040	3.0-4.0	15.0-18.0	4.0-6.0	...	0.08-0.20
S20200	202	0.15	7.5-10.0	0.060	0.030	1.00	17.0-19.0	4.0-6.0	...	0.25
S20400	...	0.030	7.0-9.0	0.040	0.030	1.00	15.0-17.0	1.50-3.00	...	0.15-0.30
S20910	XM-19 ^H	0.06	4.0-6.0	0.040	0.030	0.75	20.5-23.5	11.5-13.5	1.50-3.00	0.20-0.40	...	Cb 0.10-0.30
S21400	XM-31 ^J	0.12	14.0-16.0	0.045	0.030	0.30-1.00	17.0-18.5	1.00	...	0.35 MIN	...	V 0.10-0.30
S21600	XM-17 ^J	0.08	7.5-9.0	0.045	0.030	0.75	17.5-22.0	5.0-7.0	2.00-3.00	0.25-0.50
S21603	XM-18 ^J	0.03	7.5-9.0	0.045	0.030	0.75	17.5-22.0	5.0-7.0	2.00-3.00	0.25-0.50
S21800	...	0.10	7.0-9.0	0.060	0.030	3.5-4.5	16.0-18.0	8.0-9.0	...	0.08-0.18
S24000	XM-29 ^H	0.08	11.5-14.5	0.060	0.030	0.75	17.0-19.0	2.3-3.7	...	0.20-0.40
S30100	301	0.15	2.00	0.045	0.030	1.00	16.0-18.0	6.0-8.0	...	0.10
S30103	301L ^G	0.03	2.00	0.045	0.030	1.00	16.0-18.0	6.0-8.0	...	0.20
S30153	301LN ^G	0.03	2.00	0.045	0.030	1.00	16.0-18.0	6.0-8.0	...	0.07-0.20
S30200	302	0.15	2.00	0.045	0.030	0.75	17.0-19.0	8.0-10.0	...	0.10
S30400	304	0.08	2.00	0.045	0.030	0.75	18.0-20.0	8.0-10.5	...	0.10
S30403	304L	0.030	2.00	0.045	0.030	0.75	18.0-20.0	8.0-12.0	...	0.10
S30409	304H	0.04-0.10	2.00	0.045	0.030	0.75	18.0-20.0	8.0-10.5	...	0.10
S30415	...	0.04-0.06	0.80	0.045	0.030	1.00-2.00	18.0-19.0	9.0-10.0	Ce 0.03-0.08
S30451	304N	0.08	2.00	0.045	0.030	0.75	18.0-20.0	8.0-10.5	...	0.12-0.18
S30452	XM-21 ^J	0.08	2.00	0.045	0.030	0.75	18.0-20.0	8.0-10.5	...	0.10-0.16
S30453	304LN	0.030	2.00	0.045	0.030	0.75	18.0-20.0	8.0-12.0	...	0.16-0.30
S30500	305	0.12	2.00	0.045	0.030	0.75	18.0-20.0	10.5-13.0	...	0.10-0.16
S30600	...	0.18	2.00	0.020	0.020	3.7-4.3	17.0-18.5	14.0-15.5	0.20	...	0.50	...
S30601	...	0.015	0.50-0.80	0.030	0.013	5.0-5.6	17.0-18.0	17.0-18.0	0.05	0.35	...	Al 0.80-1.50
S30615	...	0.16-0.24	2.00	0.030	0.030	3.2-4.0	17.0-19.5	13.5-16.0	...	0.14-0.20	...	Ce 0.03-0.08
S30815	...	0.05-0.10	0.80	0.040	0.030	1.40-2.00	20.0-22.0	10.0-12.0
S30908	309S	0.08	2.00	0.045	0.030	0.75	22.0-24.0	12.0-15.0
S30909	309H ^G	0.04-0.10	2.00	0.045	0.030	0.75	22.0-24.0	12.0-15.0
S30940	309Cb ^G	0.08	2.00	0.045	0.030	0.75	22.0-24.0	12.16.0	Cb 10
XC6MIN												1.10 MAX
S30941	309HCb ^G	0.04-0.10	2.00	0.045	0.030	0.75	22.0-24.0	12.0-16.0	Cb 10XC
S31008	310S	0.08	2.00	0.045	0.030	1.50	24.0-26.0	19.0-22.0	1.10 max
S31009	310H ^G	0.04-0.10	2.00	0.045	0.030	0.75	24.0-26.0	19.0-22.0
S31040	310Cb ^G	0.08	2.00	0.045	0.030	1.50	24.0-26.0	19.0-22.0	Cb 10xC min
												1.10 max

STAINLESS STEEL PLATES - CHEMICAL COMPOSITION

UNS Designation ^a	Type ^c	Carbon ^d	Manganese	P _{total} ^e	Sulphur	Silicon	Chromium	Nickel	Molybdenum	Nitrogen	Copper	Other Elements ^{e,f}
S31041	310HCb ^g	0.04-0.10	2.00	0.045	0.030	0.75	24.0-26.0	19.0-22.0	Cb 10xc min, 1.10 max
S31050	310MoLN ^g	0.020	2.00	0.030	0.010	0.50	24.0-26.0	20.5-23.5	1.60-2.60	0.09-0.15
S31254	...	0.020	1.00	0.030	0.010	0.80	19.5-20.5	17.5-18.5	6.0-6.5	0.18-0.22	0.50-1.00	...
S31266	...	0.030	2.0-4.0	0.035	0.020	1.00	23.0-25.0	21.0-24.0	5.2-6.2	0.35-0.60	1.00-2.50	W 1.50-2.50
S31600	316	0.08	2.00	0.045	0.030	0.75	16.0-18.0	10.0-14.0	2.00-3.00	0.10
S31603	316L	0.030	2.00	0.045	0.030	0.75	16.0-18.0	10.0-14.0	2.00-3.00	0.10
S31609	316H	0.04-0.10	2.00	0.045	0.030	0.75	16.0-18.0	10.0-14.0	2.00-3.00	Ti 5xc (C+N)
S31635	316Ti	0.08	2.00	0.045	0.030	0.75	16.0-18.0	10.0-14.0	2.00-3.00	0.10	...	min 0.70 max
S31640	316Cb	0.08	2.00	0.045	0.030	0.75	16.0-18.0	10.0-14.0	2.00-3.00	0.10	...	Cb 10xc
S31651	316N	0.08	2.00	0.045	0.030	0.75	16.0-18.0	10.0-14.0	2.00-3.00	0.10-0.16	...	min, 1.10 max
S31653	316LN	0.030	2.00	0.045	0.030	0.75	16.0-18.0	10.0-14.0	2.00-3.00	0.10-0.16
S31700	317	0.08	2.00	0.045	0.030	0.75	18.0-20.0	11.0-15.0	3.0-4.0	0.10
S31703	317L	0.030	2.00	0.045	0.030	0.75	18.0-20.0	11.0-15.0	3.0-4.0	0.10
S31725	317LM ^g	0.030	2.00	0.045	0.030	0.75	18.0-20.0	13.5-17.5	4.0-5.0	0.20
S31726	317LMN ^g	0.030	2.00	0.045	0.030	0.75	17.0-20.0	13.5-17.5	4.0-5.0	0.10-0.20
S31753	317LN	0.030	2.00	0.045	0.030	0.75	18.0-20.0	11.0-15.0	3.0-4.0	0.10-0.22
S32050	...	0.030	1.50	0.035	0.020	1.00	22.0-24.0	20.0-23.0	6.0-6.8	0.21-0.32	0.40	Ti 5 x (C+N)
S32100	321	0.08	2.00	0.045	0.030	0.75	17.0-19.0	9.0-12.0	...	0.10	...	min 0.70 max
S32109	321H	0.04-0.10	2.00	0.045	0.030	0.75	17.0-19.0	9.0-12.0	9.0-12.0	Ti 4 x (C+N)
S32615	...	0.07	2.00	0.045	0.030	4.8-6.0	16.5-19.5	19.0-22.0	0.30-1.50	...	1.50-2.50	min 0.70 max
S32654	...	0.020	2.0-4.0	0.030	0.005	0.50	24.0-25.0	21.0-23.0	7.0-8.0	0.45-0.55	0.30-0.60	...
S33228	...	0.04-0.08	1.00	0.020	0.015	0.30	26.0-28.0	31.0-33.0	Ce 0.05-0.10
S33400	334 ^e	0.08	1.00	0.030	0.015	1.00	18.0-20.0	19.0-21.0	Cb 0.6-1.0
S34565	...	0.030	5.0-7.0	0.030	0.010	1.00	23.0-25.0	16.0-18.0	4.0-5.0	0.40-0.60	...	Al 0.025
S34700	347	0.08	2.00	0.045	0.030	0.75	17.0-19.0	9.0-13.0	Al 0.15-0.60
S34709	347H	0.04-0.10	2.00	0.045	0.030	0.75	17.0-19.0	9.0-13.0	Ti 0.15-0.60
S34800	348	0.08	2.00	0.045	0.030	0.75	17.0-19.0	9.0-13.0	Cb 10 x c min
S34809	348H	0.04-0.10	2.00	0.045	0.030	0.75	17.0-19.0	9.0-13.0	1.00 max
S35045	...	0.06-0.10	1.50	0.045	0.015	1.00	25.0-29.0	32.0-37.0	Cb 8 x c min
S35135	...	0.08	1.00	0.045	0.015	0.60-1.00	20.0-25.0	30.0-38.0	4.0-4.8	1.00 max
S35315	...	0.04-0.08	2.00	0.040	0.030	1.20-2.00	24.0-26.0	34.0-36.0	...	0.12-0.18	0.75	(Cb+Ta) 10 x c
S38100	XM-15	0.08	2.00	0.030	0.030	1.50-2.50	17.0-19.0	17.0-18.0	min 1.00 max
S31200	...	0.030	2.00	0.045	0.030	1.00	24.0-26.0	5.5-6.5	1.20-2.00	0.14-0.20	...	Ta 0.10
S31260	...	0.03	1.00	0.030	0.030	0.75	24.0-26.0	5.5-7.5	2.5-3.5	0.10-0.30	0.20-0.80	Co 0.20
S31803	...	0.03	2.00	0.030	0.020	1.00	21.0-23.0	4.5-6.5	2.5-3.5	0.08-0.20	...	Al 0.15-0.60
S32001	...	0.030	4.0-6.0	0.040	0.030	1.00	19.5-21.5	1.00-3.00	0.60	0.05-0.17	1.00	Ti 0.15-0.60
S32205	2205 ^g	0.030	2.00	0.030	0.020	1.00	22.0-23.0	4.5-6.5	3.0-3.5	0.14-0.20	...	Ti 0.40-1.00
Duplex (Austenitic Ferritic)												
S31200	...	0.030	2.00	0.045	0.030	1.00	24.0-26.0	5.5-6.5	1.20-2.00	0.14-0.20	...	Ce 0.03-0.10
S31260	...	0.03	1.00	0.030	0.030	0.75	24.0-26.0	5.5-7.5	2.5-3.5	0.10-0.30	0.20-0.80	...
S31803	...	0.03	2.00	0.030	0.020	1.00	21.0-23.0	4.5-6.5	2.5-3.5	0.08-0.20
S32001	...	0.030	4.0-6.0	0.040	0.030	1.00	19.5-21.5	1.00-3.00	0.60	0.05-0.17	1.00	...
S32205	2205 ^g	0.030	2.00	0.030	0.020	1.00	22.0-23.0	4.5-6.5	3.0-3.5	0.14-0.20

SS PLATES

A 240 / A240M

UNS Designation ^a	Type ^c	Carbon ^d	Manganese	Phosphorus	Sulphur	Silicon	Chromium	Nickel	Molybdenum	Nitrogen	Copper Elements ^{e,f}	Other
S32304	2304 ^g	0.030	2.50	0.040	0.030	1.00	21.5-24.5	3.0-5.5	0.05-0.60	0.05-0.60	0.05-0.60	...
S32520	...	0.030	1.50	0.035	0.020	0.80	24.0-26.0	5.5-8.0	3.0-4.0	0.20-0.35	0.50-2.00	...
S32550	255 ^g	0.040	1.50	0.040	0.030	1.00	24.0-27.0	4.5-6.5	2.9-3.9	0.10-0.25	1.50-2.50	...
S32750	2507 ^g	0.030	1.20	0.035	0.020	0.80	24.0-26.0	6.0-8.0	3.0-5.0	0.24-0.32	0.50	...
S32760	...	0.030	1.00	0.030	0.010	1.00	24.0-26.0	6.0-8.0	3.0-4.0	0.20-0.30	0.50-1.00	w 0.50-1.00
S32900	329	0.080	1.00	0.040	0.030	0.75	23.0-28.0	2.0-5.00	1.00-2.00
S32950	...	0.030	2.00	0.035	0.010	0.60	26.0-29.0	3.5-5.2	1.00-2.50	0.15-0.35
Ferritic or Martensitic (Chromium)												
S32803	...	0.015	0.50	0.020	0.035	0.55	28.0-29.0	3.0-4.0	1.80-2.50 (C+N)0.030	0.020	min, 0.15-0.50	Cb 12x(C+N)
S40500	405	0.08	1.00	0.040	0.030	1.00	11.5-14.5	0.60	Al 0.10-0.30
S40900 ^L	409	0.030	1.00	0.040	0.020	1.00	10.5-11.7	0.50	...	0.030	0.50 max, Cb 0.17	Ti 6x(C+N) min,
S40910	...	0.030	1.00	0.040	0.020	1.00	10.5-11.7	0.50	...	0.030	Ti 0.15-0.50	Ti 8x(C+N) min,
S40920	...	0.030	1.00	0.040	0.020	1.00	10.5-11.7	0.50	...	0.030	Cb 0.10	(Ti+Cb)[0.08+8
S40930	...	0.030	1.00	0.040	0.020	1.00	10.5-11.7	0.50	...	0.030	x(C+N) min 0.75 max	
S40945	...	0.030	1.00	0.040	0.030	1.00	10.5-11.7	0.50	...	0.030	Ti 0.05 min	Cb 0.18-0.40
S40975	...	0.030	1.00	0.040	0.030	1.00	10.5-11.7	0.50-1.00	...	0.030	Ti 0.05-0.20	Ti 6x (C+N)
S40977	...	0.030	1.50	0.040	0.015	1.00	10.5-12.5	0.30-1.00	...	0.030	min, 0.75 max	...
S41000	410	0.08-0.15	1.00	0.040	0.030	1.00	11.5-13.5	0.75
S41003	...	0.030	1.50	0.040	0.030	1.00	10.5-12.5	1.50	...	0.030
S41008	410S	0.08	1.00	0.040	0.030	1.00	11.5-13.5	0.60
S41045	...	0.030	1.00	0.040	0.030	1.00	12.0-13.0	0.50	...	0.030	...	Cb 9x (C+N)
S41050	...	0.04	1.00	0.045	0.030	1.00	10.5-12.5	0.60-1.10	...	0.10	min, 0.60 max	...
S41500 ^M	...	0.05	.50-1.00	0.030	0.030	0.60	11.5-14.0	3.5-5.5	0.50-1.00
S42035	...	0.08	1.00	0.045	0.030	1.00	13.5-15.5	1.0-2.5	0.2-1.2	Ti 0.30-0.50
S42900	429 ^g	0.12	1.00	0.040	0.030	1.00	14.0-16.0
S43000	430	0.12	1.00	0.040	0.030	1.00	16.0-18.0	0.75
S43035	439	0.07	1.00	0.040	0.030	1.00	17.0-19.0	0.50	...	0.04	[0.20+4(C+N)] min, 1.10 max	Ti
S43400	434	0.12	1.00	0.040	0.030	1.00	16.0-18.0	...	0.75-1.25	...	Al 0.15	...
S43600	436	0.12	1.00	0.040	0.030	1.00	16.0-18.0	...	0.75-1.25	Cb 5xc
S43932	...	0.030	1.00	0.040	0.030	1.00	17.0-19.0	0.50	...	0.030	min,0.80 max	(Ti+Cb)
S43940	...	0.030	1.00	0.040	0.015	1.00	17.5-18.5	0.030	[0.20+4(C+N)] min, 0.75 max	Ti 0.10-0.60Cb
S44400	444	0.025	1.00	0.040	0.030	1.00	17.5-19.5	1.00	1.75-2.50	0.035	Al 0.15	(Ti+Cb) [

STAINLESS STEEL PLATES - CHEMICAL COMPOSITION

UNS Designation ^B	Type ^C	Carbon ^D	Manganese	Phosphorus	Sulphur	Silicon	Chromium	Nickel	Molybdenum	Nitrogen	Copper	Other Elements ^{E,F}
S44500	...	0.020	1.00	0.040	0.012	1.00	19.0-21.0	0.60	0.03	0.30-0.60	Cb 10x)(C+N) min, 0.80 max
S44626	XM-33 ^J	0.06	0.75	0.040	0.020	0.75	25.0-27.0	0.50	0.75-1.50	0.04	0.20	Ti 0.20-1.00 Ti 7 (C+N) min
S44627	XM-27 ^J	0.010 ^V	0.40	0.020	0.020	0.40	25.0-27.5	0.50	0.75-1.50	0.015 ^W	0.20	Cb 0.05-0.20 (Ni+Cu) 0.50
S44635	...	0.025	1.00	0.040	0.030	0.75	24.5-26.0	3.5-4.5	3.5-4.5	0.035	...	(Ti+Cb) [0.20+4 (C+N)] min 0.80 max
S44660	...	0.030	1.00	0.040	0.030	1.00	25.0-28.0	1.0-3.5	3.0-4.0	0.040	...	(Ti+Cb) 0.20 - 1.00, Ti + Cb 6 x (C+N) min
S44700	...	0.010	0.30	0.025	0.020	0.20	28.0-30.0	0.15	3.5-4.2	0.020	0.15	(C+N) 0.025
S44735	...	0.030	1.00	0.040	0.030	1.00	28.0-30.0	1.00	3.6-4.2	0.045	...	(Ti+Cb) 0.20-1.00 (Ti+Cb) 6 x (C+N) min
S44800 S46800	0.010 0.030	0.30 1.00	0.025 0.040	0.020 0.030	0.20 1.00	28.0-30.0 18.0-20.0	2.00-2.50 0.50	3.5-4.2 ...	0.020 0.030	0.15	(C+N) 0.025 Ti 0.07-0.30 Cb 0.10-0.60 (Ti+Cb) [0.20+4 (C+N)] min 0.80 max

- A) Maximum unless range or minimum is indicated.
- B) Designation established in accordance with practice E 527 and SAE J 1086.
- C) Unless otherwise indicated, a grade designation originally assigned by the American Iron and Steel Institute (AISI)
- D) Carbon analysis shall be reported to nearest 0.01% except for the low-carbon type, which shall be reported to nearest 0.001 %
- E) The terms Columbium (Cb) and Niobium (Nb) both related to the same element.
- F) When two minimums or two maximums are listed for a single type, as in the case of both a value from a formula and an absolute value, the higher minimum or lower maximum shall apply.
- G) Common name, not a trademark, widely used, not associated with any one producer.
- H) Iron shall be determined arithmetically by difference of 100 minus the sum of the other specified elements.
- I) (Al + Ti) 0.85- 1.20
- J) Naming system developed and applied by ASTM.
- K) Cr + 3.3 Mo + 16 N = 40 min
- L) S40900 (Type 409) has been replaced by S40910, S40920, and S40930. Unless otherwise specified in the ordering information, an other specifying S40900 or Type 409 shall be satisfied by any one of S40910, S 40920 or S40930 at the option of the seller, Material meeting the requirements of S40910, S40920 or S40930, may at the option the manufacturer by certified as S40900.
- M) Plate version of CA-6NM
- N) Product (Check or verification) analysis tolerance over the maximum limit for C and N in XM-27 shall be 0.002 %.

STAINLESS STEEL PLATES - MECHANICAL PROPERTIES

UNS Designation	Type	Tensile Strength, min		Yield Strength, min		Elongation in 2 in. or 50 mm, min,%	Hardness, max ^c		Cold Bend ^{OD}
		Ksi	MPa	Ksi	MPa		Brinell	Rockwell B	
Austenitic (Chromium-Nickel) (Chromium- Manganese-Nickel)									
N08020	...	80	550	35	240	30.0	217	95	not required
N08367	...	100	690	45	310	30.0	...	100	not required
Sheet and Strip		95	655	45	310	30.0	241	...	not required
Plate		75	520	30	205	30.0	not required
N08800	800 ^F	65	450	25	170	30.0	not required
N08810	800H ^F	65	450	25	170	30.0	not required
N08811	...	65	450	25	170	30.0	not required
N08904	904L ^F	71	490	31	220	35.0	...	90	not required
N08926	...	94	650	43	295	35.0	not required
S20100	201-1 ^I	75	515	38	260	40.0	...	95	...
S20100	201-2 ^I	95	655	45	310	40.0	217	100	...
S20103	201L ^F	95	655	38	260	40.0	217	95	not required
S20153	201LN ^F	95	655	45	310	45.0	241	100	not required
S20161	...	125	860	50	345	40.0	255	25	not required
S20200	202	90	620	38	260	40.0	241
S20400	...	95	655	48	330	35.0	241	100	not required
S30100	301	75	515	30	205	40.0	217	95	not required
S30103	301L ^F	80	550	32	220	45.0	241	100	not required
S30153	30LN ^F	80	550	35	240	45.0	241	100	not required
S30200	302	75	515	30	205	40.0	201	92	not required
S30400	304	75	515	30	205	40.0	201	92	not required
S30403	304L	70	485	25	170	40.0	201	92	not required
S30409	304H	75	515	30	205	40.0	201	92	not required
S30415	...	87	600	42	290	40.0	217	95	not required
S30451	304N	80	550	35	240	30.0	201	92	not required
S30453	304LN	75	515	30	205	40.0	201	92	not required
S30500	305	70	485	25	170	40.0	183	88	not required
S30600	...	78	540	35	240	40.0
S30601	...	78	540	37	255	30.0	not required
S30615	...	90	620	40	275	35.0	217	95	not required
S30815	...	87	600	45	310	40.0	217	95	...
S30908	309S	75	515	30	205	40.0	217	95	not required
S30909	309H ^F	75	515	30	205	40.0	217	95	not required
S30940	309Cb ^F	75	515	30	205	40.0	217	95	not required
S30941	309HCb ^F	75	515	30	205	40.0	217	95	not required
S31008	310S	75	515	30	205	40.0	217	95	not required
S31009	310H ^F	75	515	30	205	40.0	217	95	not required
S31040	310Cb ^F	75	515	30	205	40.0	217	95	not required
S31.41	310HCb ^F	75	515	30	205	40.0	217	95	not required
S31254	...	100	690	45	310	35.0	223	96	not required
Sheet and Strip		95	655	45	310	35.0	223	96	not required
Plate		109	750	61	420	35.0	not required
S31266	...	75	515	30	205	40.0	217	95	not required
S31600	316	70	485	25	170	40.0	217	95	not required
S31603	316L	75	515	30	205	40.0	217	95	not required
S31653	316LN	75	515	30	205	40.0	217	95	not required
S31609	316H	75	515	30	205	40.0	217	95	not required
S31635	316Ti ^F	75	515	30	205	30.0	217	95	not required
S31640	316Cb ^F	75	515	30	205	30.0	217	95	not required
S31651	316N	80	550	35	240	35.0	217	95	not required
S31700	317	75	515	30	205	35.0	217	95	not required

Mechanical Test Requirements

UNS Designation ^B	Type	Tensile Strength, min		Yield Strength, ^B min		Elongation in 2 in. or 50 mm, min, %	Hardness, max ^C		Cold Bend ^{DD}
		Ksi	MPa	Ksi	MPa		Brinell	Rockwell B	
S31725	317Lm ^F	75	515	30	205	40.0	217	95	not required
S31726	317LMN ^F	80	550	35	240	40.0	223	96	not required
S31703	317L	75	515	30	205	40.0	217	95	not required
S31753	317LN	80	550	35	240	40.0	217	95	not required
S32050	...	98	675	48	330	40.0	250	...	not required
S32100	321	75	515	30	205	40.0	217	95	not required
S32109	321H	75	515	30	205	40.0	217	95	not required
S32615	...	80	550	32	220	25.0	not required
S32654	...	109	750	62	430	40.0	250	...	not required
S33228	...	73	500	27	185	30.0	217	95	not required
S33400	334	70	485	25	170	30.0	...	92	not required
S34565	...	115	765	60	415	35.0	241	100	not required
S34700	347	75	515	30	205	40.0	201	92	not required
S34709	347H	75	515	30	205	40.0	201	92	not required
S34800	348	75	515	30	205	40.0	201	92	not required
S34809	348H	75	515	30	205	40.0	201	92	not required
S35045	...	70	485	25	170	35.0	not required
S35135	...	80	550	30	205	30.0	not required
Sheet and strip	...	75	515	30	205	30.0	not required
Plate	...	94	650	39	270	40.0	217	95	not required
S35315	...	75	515	30	205	40.0	217	95	not required
S38100	XM-15	75	515	30	205	40.0	217	95	not required
S30452	XM-21	90	620	50	345	30.0	241	100	not required
Sheet and Strip	...	85	585	40	275	30.0	241	100	not required
Plate	...	84	580	39	270	25.0	217	95	not required
S31050	310MoLN ^F	78	540	37	255	25.0	217	95	not required
	t ≤ 0.25 in.								
	t > 0.25 in.								
S21600	XM-17 ^L	100	690	60	415	40.0	241	100	not required
Sheet and Strip	...	90	620	50	345	40.0	241	100	not required
Plate	...								
S21603	XM-18 ^L	100	690	60	415	40.0	241	100	not required
Sheet and Strip	...	90	620	50	345	40.0	241	100	not required
Plate	...								
S20910	XM-19 ^L	105	725	60	415	30.0	241	100	not required
Sheet and Strip	...	100	690	55	380	35.0	241	100	not required
Plate	...								
S24000	XM-29 ^L	100	690	60	415	40.0	241	100	not required
Sheet and Strip	...	100	690	55	380	40.0	241	100	not required
Plate	...								
S21400	XM-31 ^L	125	860	70	485	40.0	not required
Sheet	...	105	725	55	380	40.0	not required
Strip	...	95	655	50	345	35.0	241	100	not required
S21800	...								
Duplex (Austenitic Ferritic)									
S31200	...	100	690	65	450	25.0	293	31 ^J	not required
S31260	...	100	690	70	485	20.0	290
S31803	...	90	620	65	450	25.0	293	31 ^J	not required
S32001	...	90	620	65	450	25.0	...	25 ^G	not required
S32205	2205 ^F	90	620	65	450	25.0	293	31 ^J	not required
S32304	2304 ^F	87	600	58	400	25.0	290	32 ^J	not required
S32520	...	112	760	80	550	25.0	310	...	not required
S32550	255 ^F	110	760	80	550	15.0	302	32 ^J	not required
S32750	2507 ^F	116	795	80	550	15.0	310	32 ^J	not required

Mechanical Test Requirements

UNS Designation ^B	Type ^A	Tensile Strength, min		Yield Strength, ^B min		Elongation in 2 in. or 50 mm, min, %	Hardness, max ^C		Cold Bend ^{DD}
		Ksi	MPa	Ksi	MPa		Brinell	Rockwell B	
S32760	...	108	750	80	550	25.0	270	...	not required
S32900	329	90	620	70	485	15.0	269	28	not required
S32950 ^M	...	100	690	70	485	15.0	293	32	not required
Ferritic or Martensitic (chromium)									
S32803	...	87	600	72	500	16.0	241	100	not required
S40500	405	60	415	25	170	20.0	179	88	180
S40900 ^M	409 ^N								
S40910	...	55	380	25	170	20.0	179	88	180
S40920	...	55	380	25	170	20.0	179	88	180
S40930	...	55	380	25	170	20.0	179	88	180
S40945	...	55	380	30	205	22.0	...	80	180
S40975	...	60	415	40	275	20.0	197	92	180
S40977	...	65	450	41	280	18.0	180	88	not required
S41000	410	65	450	30	205	20.0	217	96	180
S41003	...	66	455	40	275	18.0	223	20	not required
S41008	410S	60	415	30	205	22.0	183	89	180
S41045	...	55	380	30	205	22.0	...	80	180
S41050	...	60	415	30	205	22.0	183	89	180
S41500	...	115	795	90	620	15.0	302	32	not required
S42035	...	80	550	55	380	16.0	180	88	not required
S42900	429 ^F	65	450	30	205	22.0	183	89	180
S43000	430	65	450	30	205	22.0	183	89	180
S43035	439	60	415	30	205	22.0	183	89	180
S43400	434	65	450	35	240	22.0	...	89	180
S43600	436	65	450	35	240	22.0	...	89	180
S43932	...	60	415	30	205	22.0	183	89	180
S43940	...	62	430	36	250	18.0	180	88	not required

Mechanical Test Requirements

UNS Designation ^B	Type ^A	Tensile Strength, min		Yield Strength, ^B min		Elongation in 2 in. or 50 mm, min, %	Hardness, max ^C		Cold Bend ^D
		Ksi	MPa	Ksi	MPa		Brinell	Rockwell B	
S44400	..	60	415	40	275	20.0	217	96	180
S44500	..	62	427	30	205	22	..	83	180
S44626	xm-33 ^L	68	470	45	310	20.0	217	96	180
S44627	xm-27 ^L	65	450	40	275	22.0	187	90	180
S44635	...	90	620	75	515	20.0	269	28 ^F	180
S44660	...	85	585	65	450	18.0	241	100	180
S44700	...	80	550	60	415	20.0	223	20 ^F	180
S44735	...	80	550	60	415	18.0	255	25 ^F	180
S44800	...	80	550	60	415	20.0	223	20 ^F	180
S46800	...	60	415	30	205	22	...	90	180

- A) Unless otherwise indicated, a grade designation originally assigned by the American iron and Steel Institute (AISI).
- B) Yield strength shall be determined by the offset method at 0.2% in accordance with Test Methods with Test Definitions A 370. Unless otherwise specified (see specification A 480/A, 480, paragraph 4.1.11, Ordering information), an alternative method of determining yield strength may be based on total extension under load 0.5%.
- C) Either Brinell or Rockwell B Hardness is permissible.
- D) Bend test are required to chromium steels (ferritic or martensitic) thicker than 1 in. (25 mm) or for any austenitic or duplex (austenitic-ferritic) stainless steels regardless of thickness.
- E) Elongation for thickness, less than 0.015 in. (0.38 mm) shall be 20% minimum, in 1 in (25.4 mm)
- F) Common name, not a trademark, widely used, not associated with any one producer.
- G) Yield strength requirements shall not apply to material under 0.020 in (0.50 mm) in thickness.
- H) Not applicable for thickness under 0.010 in. (0.25 mm)
- I) Type 201 is generally produced with CHEMICAL COMPOSITION BALANCED FOR RICH SIDE (type 201-1) OR LEAN SIDE (Type 201-2) AUSTENITE STABILITY DEPENDING ON THE PROPERTIES REQUIRED FOR SPECIFIC APPLICATION.
- J) Rockwell C scale.
- K) For S32615, the grain size a determined in accordance with the Test Methods E 112, Comparison Method, Plate II, shall be No. 3 or finer.
- L) Naming system developed and applied by ASTM
- M) Prior to Specification A 240-89b, the tensile value for S32950 was 90 ksi.
- N) S40900 (Type 409) has been replaced by S40910, S40920, and S40930. Unless otherwise specified in the ordering information, an order specifying S40900 or Type 409 shall be satisfied by any one of S40910 S40920, S40930 at the option of the seller, Material meeting the requirements of S40910, S40920, or S40930, may at the option of the manufacturer be certified as S40900.
- O) Material 0.050 in (1.27 mm) and under in thickness shall have a minimum elongation of 20 %.

CARBON STEEL PLATES - IS 8500 / SAILMA

CHEMICAL COMPOSITION							MECHANICAL PROPERTIES										
Grade	Ladle Analysis						Grade	Tensile Strength (Min) MPa	Yield Strength (Min)				Elongation Percent (Min) 5.65√So	Bend (Internal diameter)		Charpy V-notch Impact toughness, Joules, Min (Average of 3 Values) Room Temp ^o -20°C	
	C% Max	Mn% Max	S% Max	P% Max	Si% Max	C.E% Max			<16 mm	16-40 mm	41-63 mm	>63 mm		Min <12 mm	12-25 mm		
IS 8500							IS 8500										
Fe 440	.20	1.30	.050 .040	.050 .040	45	40	Fe 440	440	300	290	280	By agreement	22	2t	3t	-	-
Fe 440B	.20	1.30	.050 .040	.050 .040	45	40	Fe 440B	440	300	290	280	-	22	2t	3t	50	30
Fe 490	.20	1.50	.050 .040	.050 .040	45	42	Fe 490	490	350	330	320	-	22	2t	3t	-	-
Fe 490B	.20	1.50	.050 .040	.050 .040	45	44	Fe 490B	490	350	330	320	-	22	2t	3t	50	25
Fe 540	.20	1.60	.045 .040	.045 .040	45	44	Fe 540	540	410	390	380	-	20	2t	3t	-	-
Fe 540B	.20	1.60	.045 .040	.045 .040	45	44	Fe 540B	540	410	390	380	-	20	2t	3t	50	25
Fe 570	.22	1.60	.045 .040	.045 .040	45	46	Fe 570	570	450	430	420	-	20	2t	3t	-	-
Fe 570B	.22	1.60	.045 .040	.045 .040	45	46	Fe 570B	570	450	430	420	-	20	2t	3t	45	20
Fe 590	.22	1.60	.045 .040	.045 .040	45	48	Fe 590	590	450	430	420	-	20	2t	3t	-	-
Fe 590B	.22	1.80	.045 .040	.045 .040	45	48	Fe 590B	590	450	430	420	-	20	2t	3t	45	20

SAILMA High Strength Micro Alloy Structural steel (Semi Killed)

CHEMICAL COMPOSITION						MECHANICAL PROPERTIES					
Grade	C% Max	Mn% Max	S% Max	P% Max	Nb+V+Ti% Max	Grade	UTS (MPa)	YS (MPa) Min	El.% Min 5.65√So	IMPACT CHARPYV Joules (Min)	Bend Test
SAILMA 300	0.25	1.50	0.055	0.055	0.20	SAILMA300	440-560	300	20	0°C-20°C	3T
SAILMA 300HI	0.20	1.50	0.040	0.040	0.20	SAILMA300HI	440-560	300	21	40	3T
SAILMA 350	0.25	1.50	0.040	0.040	0.20	SAILMA350	490-610	350	20	-	3T
SAILMA 350 HI	0.20	1.50	0.040	0.040	0.20	SAILMA350HI	490-610	350	21	40 30	3T
SAILMA 410	0.25	1.50	0.040	0.040	0.20	SAILMA410	510-660	410	19	-	3T
SAILMA 410HI	0.20	1.50	0.040	0.040	0.20	SAILMA410HI	540-660	410	20	35 25	3T
SAILMA 450	0.25	1.50	0.040	0.040	0.20	SAILMA450	570-720	450	18	-	3T
SAILMA 450HI	0.20	1.50	0.040	0.040	0.20	SAILMA450 HI	570-720	450	19	30 20	3T

IS - 2002 - 62 STEEL PLATES FOR BOILERS

Designation	Chemical Composition					Tensile test			Elongation	
	C max	mn	si max	P max	S max	Tensile Strength Kf/mm ²	Yield Strength Kf/mm ² min		Test	% min piece
IS 2002-1	0.18	0.5 1.2	0.15-0.35	0.035	0.040	36.7-49	24	23	5.65/Sc	24
IS 2002-2	0.20	0.5 1.2	0.15-0.35	0.035	0.40	41.7-54	27	26	5.65/Sc	22
IS 2002-3	0.22	0.5 1.2	0.15-0.35	0.035	0.040	46.8-59	29.5	29	5.65/Sc	21

IS - 2062 - 92 STEEL FOR GENERAL STRUCTURAL PURPOSE

Grade	Designation	%Chemical Composition						Supply Tensile	Tensile Strength (min) Kg/mm ²	Yield Strength (min) kg/mm ²			% El in gauge length 5.56/so	Bend Test	Std. Test Piece Charpy V Notch Impact Energy joule min	Remark
		C max	Mn max	S max	P max	Si max	CE max			<20 mm	20-40 min	>40 min				
A	Fe 410 WA	0.23	1.5	0.050	0.050	-	0.42	As rolled	41.8	25.50	24.48	23.45	23	31	-	
B	FE410WB	0.22	1.5	0.045	0.045	0.40	0.41	As Rolled Plates above 12mm may be normalised if agreed to between manufacturer & purchaser	41.8	25.50	24.48	23.45	21 for < 25 mm 3t for > 25 mm	23	27	min Charpy impact energy to be guaranteed at O-C agreed betn. mfrs. purchaser
C	FE410WC	0.20	1.5	0.040	0.040	0.40	0.39	As Rolled Plates above 12mm shall be normalise	41.8	25.50	24.48	23.45	23	21	27	impact properties to be guaranteed at any one of two temp. - 20c or 40 c as specified by purchaser

ASTM A 537 - 35 PRESSURE VESSEL PLATES, HEAT TREATED, CARBON MANGANESES-SILICON STEEL

Designation	%Chemical Composition										Heat Treatment	Tensile Strength			Elongation % min	
	C Max		Min. thickness in mm		P max	S max	Cu max	Ni max	Cr max	Mo max		Thickness in mm	Tensile Strength Ksi (MPa)	Yield Strength Ksi (MPa) min	GL= 8 in or 200 mm	GL = 2 in or 50 mm
			t<1-1/2(38)	t>-1-1/2												
A 537 -1	0.24	0.15-0.50	0.70-1.35	1.0-1.60	0.035	0.040	0.035	0.25	0.25	0.08	Normalised	t<2-1 (64) 2-1/2-t <4 (100)	70-90 (485-620) 65-85 (450-585)	50 (345) 45 (310)	18	22
A 537 -2	0.24	0.15-0.50	0.70-1.35	1.0-1.60	0.035	0.040	0.035	0.25	0.25	0.08	Quenched & Tempered	T<2-1/2(64) 2-1/2-t (4)(100)	80-100 (550-690) 75-95 (515-655)	60 (415) 55 (380)	-	22

ASTM A 285 - 80 PRESSURE VESSEL PLATES, CARBON STEEL LOW AND INTERMEDIATE TENSILE

Designation	Chemical Composition				Chemical Composition			
	C max	Mn max	P max	S max	Tensile Strength Ksi(MPa)	Yield Strength Ksi (Mpa)	Elongation % mm Gl + 8 in	Gl = 2 in
A 285	0.7	0.90	0.035	0.035	45-65 (310-450))	24(165)	27	30
A 285 B	0.22	0.90	0.035	0.035	50-70 (385-485)	27(185)	25	28
A 285 C	0.28	0.90	0.035	0.035	55-75 (380-515)	30(205)	23	27

ASTM A515-78 PRESSURE VESSEL PLATES, CARBON STEEL, FOR INTERMEDIATE & HIGHER TEMP. SERVICE

Designation	Chemical Composition, %						Tensile Test			
	Thickness in (mm)	C max	Si	Mn max	P max	S max	Tensile Strength Ksi (MPa)	Yield Strength Ksi (Mpa), min	Elongation,% min	
									GI=8 in. *2	GI=2 in
A 515-55	1<t(25) 1<t<2 (50) 2<t<4(100) 4<t<8 (200) t<1	0.20 0.22 0.24 0.26 0.28	0.15-0.30	0.90	0.035	0.04	55-75 (380-515)	30(205)	23	27
A 515-60	t<1 (25) 1<t<2 (50) 2<t<4 (100) 4<t<8 (200) t<8	0.24 0.27 0.29 0.31 0.31	0.15-0.30	0.90	0.035	0.04	60-80 (415-550)	32(220)	21	25
A 515-65	t<1 (25) 1<t<2 (50) 2<t<4 (100) 4<t<8(200) t<8	0.28 0.31 0.33 0.33 0.33	0.15-0.30	0.90	0.035	0.04	65-85 (450-585)	35(240)	19	23
A 515-70	t<1 (25) 1<t<2 (50) 2<t<4< (100) 4<t<8 (200) t<8	0.31 0.33 0.35 0.35 0.35	0.15-0.30	0.90	0.035	0.04	70-90 (485-620)	38(260)	17	21

ASTM A515-78 PRESSURE VESSEL PLATES, CARBON STEEL, FOR INTERMEDIATE AND LOWER TEMP. SERVICE

Designation	Chemical Composition, %						Tensile Test			
	Thickness in (mm)	C max	Si	Mn max	P max	S max	Tensile Strength Ksi (MPa)	Yield Strength Ksi (MPa), min or 200 mm	Elongation,% min	
									GI=8 in. *2 or 50 mm	GI=2 in
A 516-55	T<1/2 (13)	0.18	0.15~0.30	0.60~0.90	0.035	0.04	55-75 (380-515)	30(205)	23	27
	1<t<2(50) 2<t<4(100) 4<t<8 (200) t>8	0.20 0.22 0.24 0.26	0.15-0.30	0.60~1.20	0.035	0.04				
A 516-60	T<1/2 (13)	0.21	0.15~0.30	0.60~0.90	0.035	0.04	60-80 (415-550)	32(220)	21	25
	1<t<2 (50) 2<t<4 (100) 4<t<8 (200) t<8	0.23 0.25 0.27 0.27	0.15-0.30	0.85~1.20	0.035	0.04				
A 516-65	t<1/2(13) 1<t<2 (50) 2<t<4 (100) 4<t<8(200) t<8	0.24 0.26 0.28 0.29 0.29	0.15-0.30	0.85~1.20	0.035	0.04	65-85 (450-585)	35(240)	19	23
A 516-70	t<1/2 (13) 1<t<2 (50) 2<t<4< (100) 4<t8 (200) t>8	0.27 0.28 0.30 0.31 0.31	0.15-0.30	0.85~1.20	0.035	0.04	70-90 (485-620)	38(260)	17	21

*1. Refer to Note *1 ASTM A.455.

*2.(1) Refer to Note *2 for ASTM A.455

(2) For plates over 3.5 in. (88.9 mm) in thickness, a deduction of 0.5% from the specified percentage of elongation in 2 in. (50 mm) shall be made for each increase of 0.5 in. of the specified thickness over 3.5 in. This deduction shall not exceed 3%.

<p>Heat Treatment</p>	<p>*1. Grade 60 plate 0.50 in (13.mm) and under in thickness may be specified to have 0.85-1.20% manganese on heat analysis.</p> <p>*2. Refer to Note *1 for ASTM A. 455.</p>
<p>Fine grain practice.</p> <p>1. plate 1.50 in (38 mm) and under in thickness are normally supplied in the as-rolled condition.</p> <p>2. plate over 1.50 in. in thickness shall be normalized.</p>	<p>*3. Refer to Note *2 for ASTM A. 455.</p>

CHEMICAL COMPOSITION

ASTM A353-78 PRESSURE VESSEL PLATES, ALLOY STEEL, 9 PERCENT NICKEL, DOUBLE - NORMALIZED & TEMPERED									
Chemical Composition, %					Tensile Test				
Designation max	C	Si max	Mn max	P max	S	Ni	Tensile Strength Ksi (MPa)	Yield Strength Ksi (MPa) min	Elongation, % min, GL = 2 in or 50 mm
A 353	0.13	0.15~0.30	0.90	0.035	0.040	8.50~9.50	100~120 (690~825)	75(515)	20

ASTM A387-78 PRESSURE VESSEL PLATES, ALLOY STEEL, CHROMIUM - MOLYBDENUM										
CHEMICAL COMPOSITION, %										
Designation	Specification	C max	Si	Mn	P max	S max	Cr	Mo	Tensile Strength Ksi (MPa)	Yield Strength (0.2% offset) Ksi (MPa) min
A 387	Grade 2	0.21	0.15~0.30	0.55~0.80	0.035	0.040	0.50~0.80	0.45~0.60	55-80 (380-550)	33 (230)
	Grade 12	0.17	0.15~0.30	0.40~0.65	0.035	0.040	0.80~1.15	0.45~0.60	55-80 (380-550)	33 (230)
	Grade 11	0.17	0.50~0.80	0.40~0.65	0.035	0.040	1.00~1.50	0.45~0.65	60-85 (415-585)	35 (240)
	Grade 22	0.15*1	0.50 max	0.30~0.60	0.035	0.035	2.00~2.50	0.90~1.10	60-85 (415-585)	30 (205)
	Grade 21	0.15*1	0.50 max	0.30~0.60	0.035	0.035	2.75~3.25	0.90~1.10	60-85 (415-585)	30 (205)
	Grade 5	0.15	0.50 max	0.30~0.60	0.040	0.030	4.00~6.00	0.45~0.65	60-85 (415-585)	30 (205)
	Grade 7	0.15	1.00 max	0.30~0.60	0.030	0.030	6.00~8.00	0.45~0.65	60-85 (415-585)	30 (205)
	Grade 9	0.15	1.00 max	0.30~0.60	0.030	0.030	8.00~10.00	0.90~1.10	60-85 (415-585)	30 (205)

- 1). The carbon content for plates over 5 inch (127 mm) in thickness is 0.17% max. on product analysis.
- *2). a) For plates under 0.312 inch (7.92 mm) in thickness, a deduction of 1.25% from the specified percentage of elongation shall be made for each decrease of 0.031 inch (0.79 mm) of the specified thickness under 0.312 inch.
- b) For plates over 3.5 inch (88.9 mm) in thickness, a deduction of 0.5% from the specified percentage of elongation in 2 inch (50 mm) shall be made for each increase of 0.05 inch of the specified thickness over 3.5 in this deduction shall not exceed 3%
- c) For plates upto the including 3/4 inch thickness, if the percentage of elongation of an 8 inch or 200 mm gauge length test specimen falls not more than 3 % below tyhe amount prescribed, the elongation shall be considered satisfactory provided the percentage of elongation in 2 inch (50 mm) across the break is not less than 25 %.
- *3). Measured on round test specimen.
- *4). Measured on flat test specimen
- *5). Applicable to annealed and normalised-tempered materials
- *6). Not applicable to annealed material

MECHANICAL PROPERTIES

ALLOY STEEL PLATES - MECHANICAL PROPERTIES ASTMA -387 GRADE 2, 5, 7, 9, 11, 12, 22 CLASS 1 & 2								
Tensile Test								
Class 1*5			Class 2*6					
Elongation %min		Reduction of area % min.	Tensile Strength Ksi(MPa)	Yield Strength (0.02%Offset) Ksi(MPa)	Elongation %, min		Reduction of Area %, min	Heat Treatment Tempering Temperature
GL=8 in.*2 or 200 mm	GL= 2in. or 50 m				GL=8 in. *2 or 200mm	GL=2 in. or 50 mm		
18	22	--	70-90 (485-620)	45 (310)	18	22	--	1,150°F(620°C)and over
18	22	--	65-85 (450-585)	40 (275)	19	22	--	
19	22	--	75-100 (515-690)	45 (310)	18	22	--	
--	18	45*3 40*4	75-100 (515-690)	45 (310)		18	45*3 40*4	1,250°F(675°C) and over
--	18	45*3 40*4	75-100 (515-690)	45 (310)		18	45*3 40*4	
--	18	45*3 40*4	75~100 (515-690)	45 (310)	--	18	45*3 40.4	1,300°F(705°C) and over
--	18	45*3 40*4	75~100 (515-690)	45 (310)	--	18	45*3 40.4	1,250°F(675°C) and over
--	18	45*3 40*4	75~100 (515-690)	45 (310)	--	18	45*3 40.4	1,250°F(675°C) and over



CHEMICAL COMPOSITION OF STAINLESS STEEL

Grade Designation		Chemical Composition			
AISI	C Max	Mn Max	P Max	S Max	Si Max
201	0.15	5.50/7.50	0.06	0.030	1.0
202	0.15	7.50/10.0	0.06	0.030	1.0
301	0.15	2.0 Max	0.045	0.040	1.0
302	0.15	2.00	0.045	0.030	1.0
303	0.15	2.00	0.045	-	1.0
304	0.08	2.00	0.045	0.030	1.0
304L	0.030	2.00	0.045	0.030	1.0
308	0.08	2.00	0.040	0.030	1.0
309	0.20	2.0 Max	0.045	0.030	1.0
309S	0.08	2.00	0.045	0.030	1.0
310	0.25	2.00	0.045	0.030	1.50
310S	0.08	2.00	0.040	0.030	1.50
314	0.25	2.00	0.045	0.030	1.5 to 3
316	0.08	2.00	0.045	0.030	1.0
316L	0.030	2.00	0.045	0.030	1.0
317	0.08	2.00	0.045	0.030	1.0
317L	0.030	2.00	0.045	0.030	1.0
316TI	0.080	2.00	0.045	0.030	1.0
321	0.08	2.00	0.045	0.030	1.0
347	0.08	2.00	0.045	0.030	1.0
430	0.12	1.00	0.040	0.030	0.75
446	0.20	1.50 Max	0.040	0.030	1.0
403	0.15	1.00	0.040	0.030	.50
410	0.15	1.00	0.040	0.030	1.00
410 S	0.08	1.00	0.040	0.030	1.0
414	0.15	1.00 Max	0.040	0.030	1.0
420	Over.15	1.00	0.040	0.030	1.00
431	0.20	1.00 Max	0.040	0.030	1.0
440A	0.60/0.70	1.00	0.040	0.030	1.0
440B	0.75	1.00	0.040	0.030	1.0
	0.95				
440C	0.95	1.00	0.040	0030	1.0
	1.2				
446	0.20	1.50	0.040	0.030	1.0

CHEMICAL COMPOSITION OF STAINLESS STEEL

Percent			Nearest Equivalent Specification		
Cr.	Ni	Mo	Other element	I.S.	En
16.0/18.0	3.5/5.5	-	N-25 max	10Cr 17Mn6Ni4	-
17.0/19.0	4.0/6.0	-	N-25 max	-	-
16.0/18.0	6.0/8.0	-	-	10Cr17Ni7	-
17.0/19.0	8.0/10.0	-	-	07Cr18Ni9	En-58A
17.0/19.0	8.0/10.0	-	-	15Cr18Ni9	En-58M
18.0/20.0	8.0/10.0	-	-	04Cr18Ni10	En-58E
18.0/20.0	8.0/10.0	-	-	02Cr18Ni11	-
10.0/21.0	10.0/12.0	-	-	-	-
22.0/24.0	12.0/15.0	-	-	20Cr24Ni12	-
22.0/24.0	12.0/15.0	-	-	-	-
24.0/26.0	19.0/22.0	-	-	10Cr25Ni12	-
24.0/26.0	19.0/22.0	-	-	-	-
25.0/26.0	19.0/22.0	-	-	-	-
16.0/18.0	10.0/14.0	2.0/3.0	-	04Cr17Ni12MO2	En 58H
16.0/18.0	10.0/14.0	2.0/3.0	-	03Cr17Ni12MO2	-
18.0/20.0	11.0/15.0	3.0/4.0	-	-	-
18.0/20.0	11.0/15.0	3.0/4.0	-	Tly5 c min	-
16.0/18.0	10.0/14.0	2.0/3.0	Ti5xC min	-	-
17.0/19.0	9.0/12.0	-	Ti5xC min	04Cr18Ni10Ti20	En-58C
17.0/19.0	9.0/12.0	-	Nb/Ta 10xC min	04Cr18NiNb-40	En-58G
14.0/18.0	0.60	-	-	07Cr17	En-60
23.0/27.0	0.60 Max	-	N-25 Max	-	-
11.5/13.0	0.60	-	-	-	-
11.5/13.5	0.60	-	-	12Cr13	En-58A
11.5/13.5	0.60 Max	-	-	-	-
11.5/13.5	1.25/2.50	-	-	-	-
12.0/14.0	0.60	-	-	22Cr13	En-56C&D
15.0/17.0	1.25/2.50	0.75 max	-	15Cr16 Ni2	En-57
16.0/18.0	-	-	-	-	-
16.0/18.0	-	0.75 max	-	-	-
16.0/18.0	-	0.75 max	-	-	-
23.0/27.0	-	-	-	NO.25 max	-

CHEMICAL COMPOSITION

Materials	Corresponding standards	Product symbol	Cu	Sn	Zn	Pb	Ni	Fe	AS	P
COPPER TUBES	ASTM B-68	C 12200	99.00							0.015-0.040
	BS 2871 Part 3	C 106	99.85			0.01		0.03	0.05	0.013-0.050
	DIN 1785	StCuF 25	99.90							0.015-0.040
	IS 2501	ETP Copper	99.90			0.005				
	BS 2871 Part 3	CN 102			...	0.01	9-11	1.0-2.0		
COPPER NICKEL TUBES 90/10	ASTM B - 111	C 70600			1.0	0.05	9-11	1.0-1.8		
	DIN 1785	Cu Ni:10 Fe 1 Mn			0.5	0.03	9-11	1.0-2.0		
	NFA 51 102	Cu Ni:10 Fe 1 Mn			0.5	0.05	9-11	1.0-2.0		
	JIS H 3300	C 7060			0.5	0.05	9-11	1.0-1.8		
	IS 1545	Cu Ni:10 Fe 1			0.5	0.05	9-1	1.0-1.8		
CUPRO NICKEL TUBES 70/30	BS 2871 Part 3	Cn 107			...	0.01	29-32	0.4-1		
	ASTM B 111	C 71500			1.0	0.05	29-33	0.4-1		
	DIN 1785	Cu Ni:30 Mn 1 Fe	Remainder		0.5	0.03	29-32	0.4-1		
	NFA51 102	Cu Ni:30 Mn 1 Fe			0.5	0.05	29-33	0.4-0.7		
	JIS H 3300	C 7150			0.5	0.05	29-33	0.0-0.7		
ADMIRALTY BRASS TUBES	IS 1545	Cu Ni:30 Mn 1 Fe			0.5	0.05	29-33	0.4-1		
	BS 2871 Part 3	CZ-III	70-73	1-1.5		0.07	...	0.06	.02-.06	...
	ASTM B - 111	C 44300	70-73	.9-1.2		0.07	...	0.06	.02-.06	...
	DIN 1785	Cu Zn 28 Sn 1	70-73	.9-1.3		0.07	0.1	0.07	.02-.06	0.01
	NFA 51 102	Cu Zn 29 Sn 1	70-73	.9-1.2		0.07	...	0.06	.02-.06	...
ALUMINIUM BRASS TUBES	JIS H 3300	C 4430	70-33	.9-1.2	Remainder	0.07	...	0.06	.02-.06	...
	IS 1545	Cu Zn 29 Sn 1 As	70-73	1-1.5		0.07	...	0.06	.02-.06	...
	BS 2871 Part 3	CZ 110	76-78			0.07	...	0.06	.02-.06	...
	ASTM B - 111	C 68700	76-79		Remainder	0.07	...	0.06	.02-.06	...
	DIN 1785	Cu Zn 20 Al 2	76-79			0.07	0.1	0.07	.02-.035	0.01
BRASS TUBES 70/30	NFA 51 102	Cu Zn 22 Al 2	76-79			0.07	...	0.06	.02-.06	...
	JIS H 3300	C 6870	76-79		Remainder	0.07	...	0.06	.02-.06	...
	IS 1545	Cu Zn 21 Al 2 AS	76-78			0.07	...	0.06	.02-.06	...
	BS 2871 Part 3	CZ 126	69-71	...	Remainder	0.07	...	0.06	.02-.06	...
	ASTM B - 135	C 26000	68.5-71.5	...		0.07005	...	
BRASS TUBES 63/37	IS 407	Cu Zn 30 As	68.5-71.5	...	Remainder	0.07	...	0.06	.02-.06	
	DIN 17671	Cu Zn 30 2.0265	69-71	0.05		0.05	0.2	0.05	...	
	IS 1545	Cu Zn 30 As	69-71	...		0.07	...	0.06	.02-.06	
	ASTM B - 135	C 27200	62-65	...	Remainder	0.07	...	0.07	...	
	DIN 17671	Cu Zn37	62-64	0.10		0.10	0.30	0.10	...	
COPPER NICKEL TUBES 90/10	IS 407	Cu Zn 37	62.95	...		0.30	...	0.010	0.06	
	JIS H3300	*C 2800	60			-				
	JIS H3300	*C 2700	63		37	-				

MECHANICAL PROPERTIES

Mn	S	C	Al	Total Impurities max.	Condition	Yield Strength N/mm ²	Tensile N/mm ²	Elongation (%)	Hardness HV 5	Grain Size mm (75X)
					050 060					0.015-0.040 0.040 min
				0.06	M,1/2H,0				105 min 80-100 60 max	0.05 max
					F25	150-240	250 min	30 min	---	---
				0.03	O D		201 min 265 min	40 min	---	---
0.5-1.0	0.05	0.05		0.30	M O	---	---	---	150 80-110	0.05 max
0.0	---	---		---	0.61 H 55	105 min 240 min	275 min 310 min	---	---	---
0.5-1.0	0.05	0.05		0.30	F29	90-180	290 min	30 min	---	---
0.3-1.0	0.02	0.05		0.10	---	---	---	---	70-100	0.040-0.045
0.2-1.0	---	---		0.50	0	---	275 min	30 min	---	0.010-0.045
0.05-1.0	---	---		0.30	O D		295 min 285 min		110 max 130 min	
0.5-1	0.08	0.06		0.30	M O		---	---	150 90-120	0.05 max
1.0	---	---		---	0.61 HR 50	125 min 345 min	360 min 495 min	35 min 30 min	---	---
0.5-1.5	0.05	0.05		0.30	F 37 F 42	120-220 150-260	370 min 420 min	35 min 30 min	---	---
0.05-1.5	0.02	0.06		0.10	---	---	---	---	90-130	0.010-0.045
0.2-1	---	---		0.50	0	---	363 min	30 min	---	0.010-0.045
0.5-1	---	---		0.30	O D		360 480	---	115 max 140 max	---
				0.30	M TA O	---	---	---	150 min 80-105 75 max	0.05 max
				---	0.61	105	310	---	---	0.01-0.045
				0.10	F 36 F 32	140-220 100-170	360 min 320 min	45 min 55 min	---	---
				0.30	---	---	---	---	80-120	0.01-0.045
				---	0	---	314 min	30 min	---	0.01-0.045
				0.3	M TA O	---	375 mpa min 340 mpa min 385 mpa min	---	80 min 80-105 130 min	0.01-0.045
			1.8-2.3	0.3	M TA O	---	---	--	150 min 85-110 75 max	0.05 max
			1.8-2.5	---	0.61	125	345	---	---	0.01-0.045
			1.8-2.3	0.1	F 39 F 34	150 - 230 120 - 180	390 min 340 min	44 min 55 min	---	---
			1.8-2.5	0.3	---	---	---	---	80-130	0.010-0.45
			1.8-2.5	---	0	---	375	40	---	0.010-0.045
			1.8-2.3	0.3	O TA HD	400 mpa max 355 mpa min 415 mpa min	---	85 max 80-110 130 min	---	0.010-0.045
			---	0.3	M TA O	---	---	---	150 min 80-105 75 max	0.05 max
			---	---	H 58 H 80	---	370 min 455 min	---	---	---
			---	0.3	O TA HD	---	285 mpa min 300 mpa min 400 mpa min	---	75 max 80-110 135 min	---
			0.02	0.1	F 28 F 35 F 42	180 mpa max 200 mpa max 320 mpa max	280-350 350-420 420 min	---	---	---
			---	0.3	O TA HD	---	375 max 340 min 385 min	55 min	80 max 80-105 130 min	---
			---	---	H 58 H 80	---	370 min 455 min	---	---	---
			0.03	0.10	F 29 F 37	180 max 200 min	290-370 370-440	50 min 27 min	---	---
			---	0.06	O TA HD	---	285 min 320 min 400 min	---	80 max 80-110 130 min	---

SPECIFICATIONS FOR BRASS RODS, SECTIONS AND FORGINGS

Material Descriptions	Indian Standard specification	British Standard specification	Composition Limits								Physical Properties				
			Copper %	Lead %	Tin %	Iron %	Manganese %	Aluminium %	Other Element %	Zinc %	Tensile strength Kg/mm ²		2% proof stress Kg/mm ² min	Elongation 0% on 5.6 /A	
Free cutting Brass type 1	319	249	56 to 59	2 to 3.5	-	0.35 max	-	-	0.7 Max	Remainder	Annealed 1/2 Hard Hard	35 to 29 41-33 56 to 50	-	Annealed 1/2 Hard	12 to 22 4 to 17 -to 4
Type II	319	-	60 to 63	2.5 to 3.7	-	0.35 Max	-	-	0.5 Max	Remainder	Annealed 1/2 hard Hard	34 to 28 40 to 32 56 to 49	13-16.5	Annealed 1/2 Hard - Hard	15 to 25 7 to 20 to 4
Forging Brass	3488	218	56.5 to 60	1.0 to 2.5	-	-	-	-	0.25 Max	Remainder	35 Min	-	-	25% Min	-
High Tensile Brass Rods Alloy I	320	-	56 to 59	0.5Max	0.75 to 1.75	1.25 Max	2.0 Max	0.2 Max	0.5 Max	Remainder	53	-	24-28	15%	-
Alloy II	320	-	56 to 59	1.0 Max	0.5 Max	0.7 to 1.2	0.5 to 1.2	0.2 to 1.2	0.5 Max	Remainder	47	-	24	20%	-
Alloy III	320	-	57 to 61	0.75 to 1.0	1.0 Max	0.25 to 1.0	0.25 to 1.0	0.5 to 2.0	0.5 Max	Remainder	53	-	28-	15 %	-

Alloy Designation	Chemical composition %					Condition	Thickness		Mechanical properties		Elongation on gauge length of 50 mm Percent	Vickers Hardness				Bend Test	
	Cu	Pb Max	Fe	Total impurities including Iron max	Zn		Over	Upto & including	Tensile Strength			Upto & including 450 mm Wide	(Kgf/mm2 over 450 mm wide)	Upto & including 450 mm			Over 450 mm wide
									N/mm2 upto & including 450 mm Wide	(Kgf/mm2 over 450 mm wide)				min	max	min	max
(1) CuZn 30	(2) 68.5 to 71.5	(3) 0.05	(4) 0.05	(5) 0.3	(6)	(7) 0 HA HB HO HS	mm (8) - - - -	mm (9) 10 10 35 10 10	min (10) 275 (28.0) 320 (32.5) 345 (35.0) 405 (41.5) 560	min (11) 275 (28.0) 320 (32.5) 345 (34.0) 380 (39.0) -	min (12) 50 - 35 - 20 - 5 -	min (13) - 75 - 100 - 125 180	max (14) 80 80 95 120 -	min (15) - 75 - 95 - 120 -	max (16) 80 80 125 -	(17) (18) 180cls 180 CLS 180 CLS 180 t 90.21	
CUZn 37	61.5 to 64.5	0.30	0.075	0.6		O HA HB HD HE HS	- - 35 - - -	10 10 35 10 10 5	275 (28.0) 335 (34.0) 380 (38.5) 450 (46.0) 515 660	275 (28.0) 320 (32.5) 345 (35.0) 405 (41.5)	40 30 15 5	80 75 110 135 165 185	80 75 100 125	180CLS 180CLS 180 CLS 180 t 90.21			
Cu Zn 40	58.5 to 61.5	0.30	0.10	0.75		O HB HD	- - -	10 10 10	(67.5) 275 (28.0) 420 (43.0) 490 (50.0)	275 (28.0) 420 (43.0) 490 (50.0)	30 12 5	85 100 125	85 100 125	180CLS 180 t 90 21			

Grade	Cu	Pb	Fe	As	Impu.	Z	Temper	Tensile	Hardness
CuZn 30As	68.5-75.5	0.07	0.06	0.02-0.06	0.30		Annealed (O) Temper annealed (TA) Hard (HD)	285 min 300 min 400 min	75 max 80-110 135 min
Cu Zn 37	62.0-65.0	0.30	0.1	0.06	0.06		Annealed (O) Temper annealed (TA) Hard (HD)	285 min 320 min 400 min	80 max 80-100 130 min
CuZn 21	76.0-78.0	0.07	0.06	0.02-0.06	-		Annealed 31.5-40.9 Drawn 58.3-70.9	-	5-110 HV 75 max 150 min
CuZn29	70.0-73.0	0.07	0.06	0.02-0.06	-		Annealed 28.3-37.8 Drawn 50.4-61.4	-	80-105HV 75 HV max 150 min

SPECIFICATION FOR COPPER RODS & SECTIONS

Material Description	Specification		Composition Limits				Tensile Strength	Physical properties	
	IIS	BSS %	Copper %	Phosphorous %	Arsenic %	Other impurities		Kg/mm ² min mm%	Elongation %
Phosphorous Deoxidised non arsenical copper	4171	2874C106	99.85 min (including silver)	0.015 to 0.05		0.06Max	Anne 21 23	33 13 Min	
Arsenical copper	288		99.20		3 to 5		22	40 Min	
High Conductivity Electrolytic Tough Pitch	613	2874C101	99.9 Min (including Silver)			0.03 Max	23.5/29.5	40 Min	99.25% IACS at 20°C
Cadmium Copper (High Conductivity wear resistance)		2874C108	Remainder		Cadmium 0.5 to 1.2 %	0.1 Min	30 Min	5% Min	80.97% 1 LACS
High conductivity Tellurium Copper		2874C109	Remainder		0.3 to 0.7%	Tellurium 0.2Max	26.5	12%	
Leaded Copper			Remainder		lead 0.6-1%	0.2 max	22.30	10%	94.98% LACS
Aluminium		2874 CA 104	Remainder	Nickel Iron 4-6 4-6	Manganese 0.5 Max	Aluminium 8-5-11	71.5	12	
Bronze Rods		CA 103	Remainder	4% Max	0.5% Max	8.8-10	53	22	

Material Descriptions	I SS ISS	BSS BSS	Copper %	Arsenic %	Phosphorous %	Lead %	Iron %	Nickel	Other Elements	Tensile Strength Kgmm ²	Elongation 4/A	Electrical Conductivity	Hardness
Phosphorous Deoxidised non Arsenical copper	2501 DHPI DHP II	2871 C106	99.85 Min		0.013 to 0.05	0.01	0.03		0.06	Anne 22 Drawn 28	Anne 40% Drawn HH		60 Max 105 Min 80-100
Phosphorous Deoxidised Arsenical copper	250 DPA	2871 C 107	99.20 Min	0.3 to 0.5	0.013 to 0.5	0.01	0.03		0.7	Anne 22 Drawn 28	Anne 40% Drawn		
High Conductivity copper tubes	2501 EP	1977 (2871) C 101	99.9 Min			0.005			0.03	Anne 20.5 to 25.2 Drawn 26.8	Anne 40% Drawn	99.25 LACS	
Cupro nickel tubes	1845 Cuni 10Fe 1	BS 2871 Part 2 CN 102	Remdr-Remdr	Manganese 0.5-1.5		0.01	1.2	10-11	0.3	Anne 30.5 to 38.5 Drawn 44 Min	30		80-110HV 150 Mn
Cupro nickel tubes	Cuni 30	CN 107	Remdr	0.5-1.5		0.01	0.4/1	30/32	0.3	Anne 37-46 Drawn 51	30		90-120 HV

INDIAN STANDARD SPECIFICATION FOR PHOSPHOR BRONZE RODS AND BARS

Chemical Composition %		Cross Sectional Thk.		Condition	0.2% Proof Stress Min N/mm ² (Kgf/mm ²)	Tensile Strength Min N/mm (Kgf/mm ²)	Elongation on Gauge Length of 5.65 A min %
Constituent	%	Over mm Upto & Incl. mm					
Tin	4.6-5.5	10	18	As Manufactured	410(42.0)	495 (50.0)	10
Lead max	0.02-0.040	18	38	As Manufactured	380 (39.0)	460 (47.0)	10
Total Impu. max	0.02	38	75	As Manufactured	315 (32.0)	385 (39.5)	15
Copper	0.2	75	110	As Manufactured	235 (24.0)	315 (32.0)	20

IS- 10773 : 95 WROUGHT COPPER TUBES FOR REFERIGERATION & AIR - CONDITIONING PURPOSE

Grade	Chemical Composition %								Condition	0.2% prof Stress MP a Min	Tensile Strength MPa		5 Elong on 50 mm Min
	Copper	Lead	Tin	Iron	Arsenica	Nickel	Phosphorus	Tot-Impu.			Min	Max	
1	99.90 Min	0.01	0.01	0.03	0.05	0.1	0.04-0.015	-	Soft annealed Light annealed Light	- - -	205 205 250	- - -	40 25

IS-733-83 CHEMICAL COMP. & PHYSICAL PROP. OF WROUGHT ALUMINIUM & ALUMINIUM ALLOY BARS, RODS & SECTIONS

Designation	Chemical composition %											Tensile strength		%Elongation Min On 50 mm
	Ai	Cu	Mg	Si	Fe	Mn	Zn	Ti	Cr..	Other	Condition	Mpa Min	Mpa Max	
19000	99.0 min	0.1	-	0.5	0.6	0.1	-	-	-	T+V=0.07	M O	65	110	18 25
19500	99.5 min	0.05	-	0.3	0.4	0.05	-	-	-	T+V=0.07	M O	65	100	23 25
24345	Remainder	3.8 5.0	0.2- 0.8	0.5- 1.2	0.7	0.3- 1.2	0.2	0.3	0.3	T+V=0.05	M O	150	240	12 12
53000	Remainder	0.1 4.0	2.8	0.6	0.5	0.5	0.2	0.2	0.25	Cr+MN=0.05	M O	215	260	14 16
63400	Remainder	0.1	0.4 0.7	0.3- 0.7	0.6	0.3	0.2	0.2	-	-	M O	110	130	12 18
64430	Remainder	0.1	0.4 1.2	0.6 1.3	0.6	0.4 1.0	0.1	0.2	0.25	-	M O	110	150	12 16

IS-737-86 CHEMICAL COM & PHYSICAL PROP. OF WROUGHT ALUMINIUM & ALUMINIUM ALLOY SHEET & STRIP

Designation	Chemical composition %											Tensile strength		Elongation on 50 mm%	
	Ai	Cu	Mg	Si	Fe	Mn	Zn	Ti	Cr..	Other	Condition	Mpa Min	Mpa Max	MPa Max	MPa Max
19990	99.9 Min		-							Cu+Sr.Fe =0.01	0 H2 H4	180 180	65 100 100		
19800	99.8 Min	0.03	-	0.18	0.15	0.06	0.06			Cu+S+Fe+ Min=0.2	0 H2 H4				
19600	99.6 Min	0.05	-	0.025	0.35	0.06	0.06			Cu+Si+Fe Min +Mn+Zn=1.0	0 H2 H4				
19000	99.0 Min	0.1	0.2	0.6		0.1	0.1			FE+Mn+Zn=1.0	0 Cu+Mg+Fe H4	H2			
24345		3.8 5.0	0.2 0.8	0.5 1.2		1.2	0.2	0.9	0.9		0 W WP				
51300		0.3	0.2 0.9	0.6		0.4	0.4	0.2	0.2		0 H2 H4				
64430		0.1	0.4 1.2	0.6 1.3		0.1	0.1	0.2	0.25		0 W WP				

CHEMICAL & PHYSICAL PROP. OF CARBON STEEL STAINLESS STEEL AND ALLOY STEEL FORGED FITTINGS

ASTM Grade	C	Mn	Si	S	P	Cr	Ni	Mo	Other	Tensile PSI(Kg/mm ²)	Yield PSI(Kg/mm ²)	Elongation %	Hardness BHN	Redn. in Area
A105	0.35 max	0.60 1.05	0.35 max	0.050 max	0.040 max	-	-	-	-	70000 49.46	36000 (25.50)	30Strip 22Round	187	30% Round
A 181 Cl 60 & 70	0.35 max	1.10 max	0.32 max	0.35 min	0.05 max	-	-	-	-	Cl.70-70000(49.46) Cl.60-60000(42.32)	30000 (20.90) 36000 (25.25)	22	-	35%
A 182 F 304	0.08 max	2.00 max	1.00 max	0.03 max	0.04 max	18.0 20.0	8.0 11.0	-	-	75000 (52.52)	30000 (20.90)	30	-	50%
A 182 F 304 L	0.085 max	2.00 max	1.00 max	0.03 max	0.04 max	18.0 20.0	8.0 13.0	-	-	70000 (49.46)	25000 (17.34)	30	-	50%
A 182 F 304 N	0.08 max	2.00 max	0.75 max	0.03 max	0.04 max	18.4 20.0	8.0 10.50	-	-	80000 (56.09)	35000 (24.47)	30(long) 25(trans)	-	50% (long) 45(trans)
A 182 F316	0.08 max	2.00 max	1.00 max	0.03 max	0.04 max	16 18.6	10.0 14.0	2.0 3.0	M=0.1-0.16	75000 (52.52)	30000 (20.90)	30	-	50%
A 182 F316L	0.35 max	2.00 max	1.00 max	0.03 max	0.04 max	16 18.0	10.0 15.0	2.0 3.0	-	70000 (49.46)	25000 (17.34)	30	-	50%
A 182 F316H	0.04 0.10	2.00 max	1.00 max	0.03 max	0.04 max	16 18.0	10. 14.0	2.0 3.0	-	75000 (52.52)	3000 (20.90)	30	-	50%
A 182 F 321	0.08 max	2.00 max	1.00 max	0.03	0.04	17 min	9 12.0	2.0 3.0	Ti=Cx5 0.70 max	75000 (52.52)	30000 (20.90)	30	-	50%
A 182 F 310	0.15 max	2.00 max	1.00 max	0.03	0.04	24.0 26.0	19.0 22.0	-	-	75000 (52.52)	3000 (20.90)	30	-	50%
A 182 F317L	0.03 max	2.00 max	1.00 max	0.03	0.045	18.0 20.0	11.0 15.0	3.0 4.0	-	70000 (49.46)	25000 (17.34)	30	-	50%
A 182 F 347H	0.04 max	2.00 max	1.00 max	0.03 max	0.04 max	17.0 20.0	9.0 13.0		Cb+Ta + -8C-1.0	75000 (52.52)	30000 (20.90)	30	-	50%
A 182 F1	0.28 max	0.60 0.90	0.15 0.35	0.045 max	0.045 max	-	-	0.44 0.65	-	70000 (49.46)	40000 (28.05)	20	143-192	30
A 182 F 12 class2	0.10 0.20	0.30 0.80	0.10 0.60	0.04 max	0.04 max	0.8 1.25	-	0.44 0.65	-	70000 (49.46)	40000 (28.05)	20	143-207	30
A 182 F 11 class 2	0.10 0.20	0.30 0.80	0.50 1.0	0.04 max	0.04 max	1.0 1.50	-	0.44 0.65	-	70000 (49.46)	40000 (28.05)	20	143-207	30
A 182 F 22 class 3	0.05 0.15	0.30 0.60	0.5 max	0.04 max	0.04 max	2.0 2.50	-	0.87 1.13	-	75000 (52.52)	45000 (31.7)	20	156-207	30
A 182 F5	0.15 max	0.30 0.60	0.5 max	0.03 max	0.03 max	4.0 6.0	0.5 max	0.44 0.65	-	70000 (49.46)	40000 (28.05)	20	143-217	35
A 182 F9	0.15 max	0.30 0.60	0.5 1.0	0.03 max	0.03 max	8.0 10.0	-	0.90 1.10	-	85000 (56.65)	55000 (38.75)	20	179-217	40

LOW TEMP. FITTING CHEMICAL & PHYSICAL PROP

ASTM Grade	C	Min	Si	S	P	Cr	Ni	Mo	Other	Tensile Ksi(MPa)	Yield Ksi(Mpa)	Elongation % Strip/Round	Impact Jules. Av. min	Redn. in Area
A350LF1	0.30 MAX	0.60 1.35	0.15 0.30	0.040 MAX	0.035 MAX	0.30 MAX	0.40 MAX	0.12 MAX	Cu-0.4 max Cb - 0.4 max Cb - 0.02 max	60.85 (415.585)	0(205)	28/35	18/14	38
LF2	0.30 MAX	0.90 MAX	0.15 0.30	0.040 MAX	0.035 MAX	0.30 MAX	0.40 MAX	0.12 MAX	Cb-0.02 max Va-0.3	0.95 (485.655)	36(250)	30/22	20/16	36
LF3	0.20 MAX	0.6 1.35	0.20 0.35	0.040 MAX	0.035 MAX	0.30 MAX	3.25 3.75	0.12 MAX	Cu-0.4 max Cb -0.02max Va-0.3 max	0.95 (485.655)	37.5(250)	30/22	20/16	35
LF5	0.30 MAX	0.60 1.35	0.20 0.35	0.040 MAX	0.035 MAX	0.30 MAX	1.0 2.0	0.12 MAX	Cu-0.4max cb-0.02max Va-0.3max	Cl.1.60.85(415.585) Cl.2.70.95(485.655)	Cl.1 30(205) Cl.2 37.5(260)	Cl.1 28/25 Cl.2 30/22	20/16	Cl.1.38 Cl.1.35
LF6	0.22 1.50	1.15 1.50	0.15 0.30	0.025 MAX	0.025 MAX	0.30 MAX	0.40 MAX	0.12 MAX	Cu-0.4 max Cb-0.02 max Va-0.04-0.11	Cl.1.66-91(455-495) Cl.2.75-100(515-690)	52(360) 60(415)	Cl.1 30/22 Cl.2 28/20	2016	40
LF9	0.20 MAX	0.40 1.06	-	0.040 MAX	0.035 MAX	0.30 MAX	1.60 2.24	-	Cb-0.02 max Cu-0.75-1.25 VA-0.03	63-88 (435-605)	46(315)	28/25	18/14	38
A 420WPL-6	0.30 MAX	0.39 1.06	0.10 MIN	0.030 MAX	0.030 MAX	-	-	-	-	60-85 (415-565)	35(240)	30/22 Long 16.5/12 Trans	17.6/13.6 17.6-13.6	
WPL - 9	0.20 MAX	0.40 1.06	-	0.030 MAX	0.030 MAX	-	1.60 2.24	-	Cu-0.75-1.25	63-88 (435-610)	46(315)	28/20 Long. 18/- Trans.	17.6/13.6 17.6/11.6	
WPL 3	0.20 MAX	0.31 0.64	0.13 0.37	0.050 MAX	0.050 MAX	-	3.18 3.82	-	-	65-90 (450-620)	35(240)	30/22Long 20/14 Trans	17.6/13.6 17.6/13.6.	
WPL 8	0.13 MAX	0.90 MAX	0.13 0.37	0.030 MAX	0.030 MAX	-	8.40 9.60	-	-	100-125 (690-865)	75(515)	22/16	33.9/27.1	

S. S. ROUND BAR CHEMICAL & PHYSICAL PROP

ASTM Grade	C	Mn	Si	S	P	Cr	Ni	Mo	Other	Tensile Ksi(MPa)	Yield Ksi(Mpa)	Elongation % Strip/Round	Impact Jules. Av. min	Redn. in Area
A479 TP 304	0.08 MAX	2.00 MAX	1.00 MAX	0.030 MAX	0.045 MAX	18.0 20.0	8.0 11.0	-	N2-0.10 MAX	75000 (515)	3000 (205)	30	-	40
A479 TP 316	0.08 MAX	2.00 MAX	1.00 MAX	0.030 MAX	0.045 MAX	16.0 18.0	10.0 14.0	2.0 3.0	N20.10 MAX	75000 (515)	30000 (250)	30	-	40
A479 TP 317 L	0.035 MAX	2.00 MAX	1.00 MAX	0.030 MAX	0.045 MAX	18.0 20.0	11.0 15.0	3.0 4.0	N2-0.10 MAX	75000 (515)	30000 (250)	30	-	40
A479 TP 310S	0.08 MAX	2.00 MAX	1.00 MAX	0.030 MAX	0.045 MAX	24.0 26.0	19.0 22.0	-	-	75000 (515)	3000 (205)	30	-	40
A479 TP 316 H	0.04 0.10	2.00 MAX	1.00 MAX	0.030 MAX	0.040 MAX	16.0 18.0	10.0 14.0	2.0 3.0	-	75000 (515)	30000 (205)	30	-	40
A479 TP 347 H	0.04 0.10	2.00 MAX	1.00 MAX	0.030 MAX	0.040 MAX	17.0 19.0	9.0 13.0	-	Ch=BxC -13.0	75000 (515)	30000 (205)	30	-	40

WEIGHT OF ALUMINIUM SHEETS

S.W.G	Inch	Millimeters	Lb	Kg	Kg 8' x 4'	Kg 8' x 3'	Kg 6' x 3'
			Sq/foot	Sq/Foot			
3/8"	.375	9.53	5.29	2.399	76.740	57.540	43.170
3/0	.372	9.45	5.24	2.376	75.890	57.080	42.810
2/0	.348	8.84	4.91	2.227	71.210	53.430	40.050
1/0	.324	8.03	4.57	2.072	66.300	49.720	37.270
5/16"	.312	7.93	4.40	1.995	63.860	47.900	35.910
1	.300	7.62	4.23	1.918	61.370	46.630	34.490
2	.276	7.01	3.89	1.764	56.410	42.350	31.750
3	.252	6.40	3.55	1.610	51.560	38.690	29.020
1/4"	.250	6.35	3.52	1.596	51.166	38.380	28.740
4	.232	5.89	3.27	1.483	47.480	35.600	26.390
5	.212	5.48	2.99	1.356	43.370	32.510	24.400
6	.192	4.88	2.71	1.229	39.280	29.480	22.080
3/16"	.187	4.75	2.64	1.197	38.270	28.710	21.530
7	.176	4.47	2.48	1.126	36.600	27.040	20.260
8	.160	4.06	2.26	1.025	32.730	24.520	18.420
9	.144	3.66	2.03	0.921	29.480	22.080	16.610
10	.128	3.25	1.80	0.816	26.170	19.650	14.730
1/8"	.125	3.18	1.76	0.798	25.570	19.190	14.370
11	.116	2.95	1.64	0.744	23.720	17.830	13.320
12	.104	2.64	1.47	0.667	21.250	15.950	11.960
13	.092	2.34	1.30	0.590	18.810	14.090	10.600
14	.080	2.03	1.13	0.512	16.320	12.240	9.210
15	.072	1.83	1.02	0.462	14.730	11.050	8.380
16	.064	1.63	0.902	0.409	13.090	9.830	7.130
17	.056	1.42	0.792	0.359	11.480	8.610	5.430
18	.048	1.22	0.677	0.307	9.830	7.330	5.520
19	.040	1.02	0.564	0.255	8.160	6.116	4.610
20	.036	0.914	0.508	0.230	7.330	5.520	4.110
21	.032	0.813	0.451	0.205	6.520	4.409	3.650
22	.028	0.711	0.395	0.179	5.720	4.300	3.190
23	.024	0.610	0.388	0.153	4.810	3.640	2.720
24	.022	0.559	0.310	0.141	4.470	3.340	2.480
25	.020	0.508	0.232	0.128	4.060	3.080	2.280
26	.018	0.457	0.254	0.115	3.650	2.740	2.030
27	0.0164	0.417	0.231	0.105			
28	0.0148	0.376	0.203	0.095			
29	0.0136	0.346	0.192	0.0871			
30	0.0124	0.315	0.175	0.0794			
31	0.0116	0.294	0.164	0.0744			
32	0.0108	0.274	0.152	0.0689			
33	0.0105	0.267	0.148	0.0671			
34	0.0092	0.233	0.130	0.0590			
35	0.0084	0.213	0.118	0.0535			
36	0.0076	0.193	0.107	0.0485			
37	0.0068	0.172	0.0959	0.0435			
38	0.0060	0.152	0.0846	0.0384			
39	0.0052	0.132	0.0733	0.0332			
40	0.0048	0.122	0.0677	0.0307			
41	0.0044	0.112	0.0620	0.0281			
42	0.0040	0.102	0.0564	0.0256			
43	0.0036	0.0915	0.0508	0.0230			
44	0.0032	0.0831	0.0452	0.0205			
45	0.0028	0.0711	0.0395	0.0179			
46	0.0024	0.0610	0.0338	0.0153			
47	0.0020	0.0508	0.0282	0.0128			
48	0.0016	0.0406	0.0226	0.0102			
49	0.0012	0.0305	0.0169	0.0077			
50	0.0010	0.0154	0.0141	0.0064			

**IS : 1239 (PART 1) - 1979 MILD STEEL TUBES
 MAXIMUM PERMISSIBLE PRESSURE AND TEMPERATURE
 FOR TUBES FOR CONVEYING STEAM**

The maximum permissible pressure and temperature for tubes with screwed and socketed joints shall be as follows.

MAXIMUM PERMISSIBLE PRESSURE AND TEMPERATURE FOR TUBES WITH STEEL COUPLINGS OR SCREWED AND SOCKETED JOINTS			
Nominal Bore mm	Maximum Permissible Pressure N/mm ²	Kg/cm ²	Maximum Permissible Temperature °C
Up to and including 25 mm	1.20	12.24	260
Over 25 mm up to and including 40 mm	1.03	10.50	260
Over 40 mm up to and including 80 mm	0.86	8.77	260
Over 80 mm up to and including 100 mm	0.69	7.04	260
Over 100 mm up to and including 125 mm	0.69	7.04	171
Over 125 mm up to and including 150 mm	0.50	5.10	160

For tubes fitted with appropriate flanges or suitably butt welded together, the maximum permissible pressure shall be 21.00 Kg/cm² and the maximum permissible temperature 260°C.

BEND TEST FLATTENING TEST

Bend Test on tubes up to and including 50 mm Nominal Bore - When tested in accordance with IS: 1239-1963, the finished tubes shall be capable of withstanding the bend test without showing any signs of fracture or failure. Welded tubes shall be bent with the weld at 90° to the plane of bending. The tubes shall not filled for this test.

Ungalvanized tubes shall be capable of being bent cold, without cracking, through 180° round a former having a radius at the bottom of groove, in the plane of bending, equal to six times the outside diameter of the tube.

Galvanized tubes shall be capable of being bent cold, without cracking, the steel through 90° round a former having a radius at the bottom of the groove, equal to eight times the outside diameter of the tube.

Flattening Test on Tubes above 50 mm Nominal Bore - Rings, not less than 40 mm in length, cut from the ends of selected tubes, shall be flattened between parallel plates with the weld if any at 90° (Point of maximum bending) in accordance with IS: 1239-1963. No opening shall occur by fracture in the weld until the distance the plates is less than 75 percent of original outside diameter of the pipe and no cracks or breaks in the metal elsewhere than in the weld shall occur until the distance between the plates is less than 60 percent of the original outside diameter.

**DIMENSIONS AND NOMINAL WEIGHTS OF BLACK
STEEL TUBES IN ACCORDANCE WITH IS: 1239 (PART 1) - 1979**

Outside diameter					Thickness						Weight of black tube				Dimension of sockets			
Nominal	Light		Medium & heavy		Light		Medium		Heavy		Light		Medium		Heavy		Outside	
	Max mm	Min mm	Max mm	Min mm	mm	swg	mm	swg	mm	swg	Plain	Screwed	Plain	Screwed	Plain	Screwed	Diameter	length
Bore mm	Max mm	Min mm	Max mm	Min mm	mm	swg	mm	swg	mm	swg	End kg/m	Socketed kg/m	End kg/m	Socketed kg/m	End kg/m	Socketed kg/m	Min mm	Min mm
6	10.1	9.7	10.6	9.8	1.8	15	2.0	14	2.65	12	0.361	0.364	0.407	0.410	0.496	0.496	15	19
8	13.6	13.2	14.0	13.2	1.8	15	2.35	13	2.9	11	0.517	0.521	0.650	0.654	0.769	0.773	18.5	27
10	17.1	16.7	17.5	16.7	1.8	15	2.35	13	2.9	11	0.674	0.680	0.852	0.858	1.02	1.03	22	28
15	21.4	21.0	21.8	21.0	2.0	14	2.65	12	3.25	10	0.952	0.951	1.22	1.23	1.45	1.46	27	37
20	26.9	26.4	27.3	26.5	2.35	13	2.65	12	3.25	10	1.41	1.42	1.58	1.59	1.90	1.91	32.5	39
25	33.8	33.2	34.2	33.3	2.65	12	3.25	10	4.05	8	2.01	2.03	2.44	2.46	2.97	2.99	39.5	46
32	42.5	41.9	42.9	42.0	2.65	12	3.25	10	4.05	8	2.58	2.61	3.14	3.17	3.84	3.87	49	51
40	48.4	47.8	48.8	47.9	2.9	11	3.25	10	4.05	8	3.25	3.29	3.61	3.65	4.43	4.47	56	51
50	60.2	59.6	60.8	59.7	2.9	11	3.65	9	4.5	7	4.11	4.18	5.10	5.17	6.17	6.24	68	60
65	76.0	75.2	76.6	75.3	3.25	10	3.65	9	4.5	7	5.80	5.92	6.51	6.63	7.90	8.02	84	69
80	88.7	87.9	89.5	88.0	3.25	10	4.05	8	4.85	6	6.81	6.98	8.47	8.64	10.1	10.3	98	75
100	113.9	113.0	115.0	113.1	3.65	9	4.5	7	5.4	5	9.89	10.2	12.1	12.4	14.4	14.7	124	87
125	-	-	140.8	138.5	-	-	4.85	6	5.4	5	-	-	16.2	16.7	17.8	18.3	151	96
150	-	-	166.5	163.9	-	-	4.85	6	5.4	5	-	-	19.2	19.8	21.2	21.8	178	96

Tolerances on Thickness and weight :

The following manufacturing shall be permitted on the tubes and sockets.

(a) Thickness :

- | | |
|-----------------------------|-----------------------------|
| (1) Butt welded Light tubes | +Not limited
-8 percent |
| Medium and Heavy tubes | +Not limited
-10 percent |
| (2) Seamless tube | -12.5 percent |

(b) Weight:

- | | |
|---|---------------------------|
| (1) Single tube (light series) | + 10percent
-8 percent |
| (2) single tube (medium and heavy series) | ± 10 percent |

ROUND BAR - METRIC

Size	Weights in kg.	
	mm Wt. per ft.	Wt. per. Mt
.5	.0004	.0015
1.0	.0018	.0062
1.5	.0042	.014
2.0	.0076	.039
2.5	.012	.039
3.0	.017	.055
3.5	.023	.076
4.0	.030	.099
4.5	.038	.125
5.0	.047	.154
5.5	.057	.187
6.0	.068	.222
6.5	.079	.260
7.0	.092	.302
7.5	.106	.347
8.0	.120	.395
8.5	.136	.445
9.0	.152	.499
9.5	.169	.556
10	.188	.617
11	.227	.746
12	.271	.888
13	.317	1.04
14	.369	1.21
15	.424	1.39
16	.482	1.58
17	.543	1.78
18	.610	2.00
19	.680	2.23
20	.753	2.47

Size	Weights in kg.	
	mm Wt. per ft.	Wt. per. Mt
21	.829	2.72
22	.908	2.98
23	.994	3.26
24	1.08	3.55
25	1.17	3.85
26	1.27	4.17
27	1.37	4.50
28	1.47	4.83
30	1.69	5.55
32	1.92	6.31
33	2.05	6.71
35	2.30	7.55
36	2.44	7.99
38	2.71	8.90
39	2.86	9.38
40	3.01	9.86
42	3.32	10.88
45	3.80	12.48
48	4.33	14.21
50	4.70	15.41
52	5.08	16.67
55	5.69	18.65
56	5.89	19.33
58	6.32	20.74
60	6.77	22.20
62	7.22	23.70
64	7.70	25.25
65	7.94	26.05
68	8.69	28.51
70	9.21	30.21

Size	Weights in kg.	
	mm Wt. per ft.	Wt. per. Mt
72	9.74	31.96
75	10.57	34.68
80	12.03	39.46
90	15.22	49.94
100	18.79	61.65
110	22.74	74.6
120	27.07	88.8
130	31.70	104
140	36.88	121
150	42.37	139
160	48.16	158
170	54.26	178
180	60.96	200
190	67.97	223
200	75.3	247
220	90.8	298
240	108	355
250	117	385
260	127	417
280	147	483
300	169	555
320	192	631
340	217	713
350	230	755
360	244	799
380	271	890
400	301	986
500	469	1540

STAINLESS , ALLOY STEELS, ROUND BAR
 WEIGHT OF S. S. ROUND
 DIA (MM) X DIA (MM) X 0.0019 KG. (PER FEET)

HEXAGONAL BAR - METRIC

Size	Weights in kg.	
	mm Wt. per ft.	Wt. per. Mt
.5	.0518	.170
5.5	.0628	.206
7	.102	.333
8	.133	.435
10	.207	.680
11	.251	.823
12	.298	.979
13	.351	1.15
14	.405	1.33
15	.466	1.53

Size	Weights in kg.	
	mm Wt. per ft.	Wt. per. Mt
16	.530	1.74
17	.597	1.96
18	.671	2.20
19	.747	2.45
20	.829	2.72
22	1.00	3.29
24	1.20	3.92
25	1.30	4.25
27	1.51	4.96
30	1.87	6.12

Size	Weights in kg.	
	mm Wt. per ft.	Wt. per. Mt
32	2.12	6.56
35	2.54	8.33
36	2.69	8.81
38	2.99	9.82
40	3.32	10.9
41	3.48	11.4
46	4.39	14.4
48	4.79	15.7
50	5.18	17.0

SQUARE BAR - METRIC

Size	Weights in kg.	
	mm Wt. per ft.	Wt. per. Mt
5	.0597	.196
5.5	.0722	.237
6	.0862	.283
7	.117	.385
8	.153	.502
9	.194	.636
10	.239	.785
11	.290	.950
12	.344	1.13
13	.405	1.33
14	.469	1.54
15	.540	1.77

Size	Weights in kg.	
	mm Wt. per ft.	Wt. per. Mt
16	.613	2.01
17	.692	2.27
18	.774	2.54
19	.863	2.83
20	.957	3.14
21	1.06	3.46
22	1.16	3.80
23	1.27	4.15
24	1.38	4.52
25	1.50	4.91
26	1.62	5.31
27	1.74	5.72

Size	Weights in kg.	
	mm Wt. per ft.	Wt. per. Mt
28	1.88	6.15
30	2.15	7.06
32	2.45	8.04
35	2.93	9.62
36	3.11	10.2
38	3.44	11.3
40	3.84	12.6
42	4.21	13.8
45	4.85	15.9
46	5.06	16.6
48	5.52	18.1
50	5.97	19.6

STAINLESS, ALLOY STEELS, HEXAGON, AND SQUARE BAR
 WEIGHT OF S. S. HEXAGONAL ROD.
 DIA (MM)X DIA (MM) X 0.002072 KG. (PER FEET)

ANGLES (Equal Sides) Angles (Equal and unequal Sides)

Sides in mm	Thickness					Weight in Kg per meter					
	3	4	5	6	8	10	12	15	16	18	20
Equivalent											
20 x 20mm	0.9	1.1									
25 x 25 mm	1.1	1.4	1.8								
30 x 30mm	1.4	1.8	2.2								
35 x 35 mm	1.6	2.1	2.6	3.0							
40 x 40 mm	1.8	2.4	3.0	3.5							
45 x 45 mm	2.1	2.7	3.4	4.0							
50 x 50 mm	2.3	3.0	3.8	4.5							
55 x 55 mm			4.1	4.9	6.4	7.9					
60 x 60 mm			4.5	5.4	7.0	8.6					
65 x 65 mm			4.9	5.8	7.7	9.4					
70 x 70 mm			5.3	6.3	8.3	10.2					
75 x 75 mm			5.7	6.8	8.9	11.0					
45 x 30 mm	1.7	2.2	2.8	3.3							
75 x 50 mm			4.7	5.6	7.4	9.0					
90 x 60 mm			6.8	8.9	11.0	13.0					
100 x 75 mm			8.0	10.5	13.0	15.4					
125 x 75 mm			9.2	12.1	14.9						
125 x 95 mm			10.1	13.3	16.5	19.6					
150 x 75 mm				13.7	16.9	20.1					
150 x 115 mm				16.2	20.0	23.8	29.5				

Size in mm	Weight kg/M	Mill
ANGLES (equal)		
50x50x6	4.5	BMM
65x65x6	5.8	BMM
65x65x8	7.7	BMM
65x65x10	9.4	BMM
75x75x6	6.8	BMM
75x75x8	8.9	BMM
75x75x10	11.0	BMM
80x80x6	7.3	BMM
80x80x8	9.6	BMM
80x80x10	11.8	BMM
90x90x6	8.2	BMM
90x90x8	10.8	BMM
90x90x10	13.4	BMM
100x100x8	12.1	DSM
100x100x10	14.9	DSM
100x100x12	17.7	DSM
110x110x10	16.6	DSM
110x110x12	19.7	DSM
130x130x10	19.7	DSM
130x130x12	23.4	DSM
150x150x16	35.8	BRSM
150x150x20	44.1	BRSM
200x200x16	48.5	BRSM
200x200x20	60.0	BRSM

ANGLES (Equal)

Designation	Size	Thickness		Weight		Designation	Size	Thickness		Weight	
		Web	Flange	Meter	Foot			Web	Flange	Meter	Foot
INST	mmxmm	mm	mm	kg	ib	ISDT	mmxmm	mm	mm	kg	lb
				(Normal tee)						(Deep Legged Tee)	
20	20x20	3	3	0.9	0.60	100	100x50	5.8	10	8.7	
						150	150x75	8.0	11.6	15.7	
20	20x20	4	4	1.1							
30	30x30	3	3	1.4	0.9	ISLT					
30	30x30	4	4	1.8		200	200X163	8.0	12.5	28.4	
						250	250X180	9.2	14.1	37.5	
40	40x 40	6	6	3.5	2.35						
50	50 x 50	6	6	5.4	3.63	ISHT		(Slit Tee From H Section)			
75	75x75	9	9	10.0		75	75x150	8.4	9.0	15.3	10.28
75	75x75	10	10	10.95		100	100x200	7.0	9.0	20.0	13.48
						125	125x250	8.8	9.7	27.4	18.41
80	80x80	8	8	9.6	6.45	150	150x250	7.9	10.6	29.4	19.76
100	100x100	10	10	14.9							
150	150x150	10	10	22.7							

Common Grades IS : 2060 SAILMA

Tolerance as per IS : 1852

Abbreviations used : DSM (Durgapur Section Mill)
 BMM (Bhilai Merchant Mill)
 BRSM (Bhilai Rail & structural Mill)

CHANNELS MILD STEEL CHANNEL, BEAMS, ANGLES STEEL SIZE WEIGHT/KG/M

Size mm	Weight Kg/m	
75x40x48	6.8	
100x50x5	9.2	
125x65x5.3	12.8	
125x66x6	13.7	
150x75x5.7	16.4	
150x75x6.5	17.7	
175x75x6	19.2	
200x75x6.2	22.2	
200x76x7.5	24.3	
250x82x9	34.2	
300x90x7.8	35.9	
400x100x8.8	49.5	
Designation	Size	Weight
	mm x mm	Kg x m
	Telegraph channel	
41T	41 x 32	4.79
1 Mtr.	Gate Channel	6.25
BEAMS		
Size mm	Weight Kg/m	
116x100	23.0	
125x70x5	13.2	
150x75x5	15.0	
175x85x5.8	19.5	
200x100x5.7	25.4	
250x125x16.9	37.3	
300x140x7.7	44.2	
450x150x9.4	72.4	
500x180x10.2	86.92	
600x210x12.00	122.6	
INP - 14 (140x66)	14.3	
INP -16 (160x74)	17.9	
INP -18 (180x82)	21.9	
350 x 140 x 8.1	52.4	
400 x 140 x 8.9	61.6	

EN SERIES STEEL

E.N. No.	Type and Application	Chemical composition & max						Physical Properties min			Limiting Size (diameter or width) Across Plats)	Condition	Brinell No.
		C	Mn	Ni	Cr.	Mo.	Others	T.I t/sq	EI %	Izod ft.lbs			
IA	Free cutting machining Steel for low duty bolts, nuts, studs etc	.07/.15	.80/1.20	-	-	-	s. .2/.3 P. .07 Si. .10	32 28 25 23 23	10 14 14 14 26	- - - - -	17/32" and less Over 17/32" to 1-1/2" Over 1-1/2" to 2 1/2" Over 2 1/2" to 4" 4" Other finishes	Cold rolled or Cold drawn	-
3	20 CARBON STEEL for aircraft sockets Plug ends, lightly stressed levers, bolts nuts	.25	1.0				S & P .06 Si .05/.35	25/35	25		6"	As rolled	
3B	20 CARBON STEEL Cold drawn	.25	1.0	-	-	-	S & P .06 Si. .35	28	25	-	-	Normalised	-
8	40CARBON STEEL without grain size control. For motor connecting rods, crankshafts, bolts and machine details in general.	.35/.45	.6/10				Si 06/.36 S & P .06	35 Q 40 H 45 35 Q 40 R 45	20 20 20 17 17 17		6" 2 1/2" 7/8" 6" 2 1/2" 7/8"	Normalized H & T H & T N & CD H & T & CD H & T & CD	152/207 179/229 201/255 152/207 169/229 201/255
8M	40 Carbon Steel. Free cutting	.35/45	.9/1.30	-	-	-	S. .12/.20 P. .06 Si. .25	35 Q 40 R 45 38	20 22 20 12	- 25 40 -	6" 2" 1/2" 1 1/2" max	Normalised H & T H & T Cold drawn	152/207 179/229 201/255 229/ max
16	Manganese-Molybdenum steel. suitable for tensile ranges of 45/75 tons according to the ruling section.	.30/.40	1.3/1.8	-	-	.20/.35	S & P. .05	R. 45 S. 50 T. 55 U. 60 V. 65	22 20 18 17 16	40 40 40 35 35	6" 4" 2.1/2" 1.1/8" 7/8"	H & T H & T H & T H & T H & T	201-255 223-277 248-302 269-321 293-341
18	1 percent Chromium Steel. suitable for tensile ranges of 45/65 tons according to the ruling section	.35/.45	.60/.95	-	.85/ 1.15	-	S. & P. .05	R. 45 S. 50 T. 55	22 20 18	40 40 40	4" PS 32 2 1/2" " 36 1.1/8" " 4.1	H & T H & T H & T	201/255 223/277 248/302

EN SERIES STEEL

E.N. No.	Type and Application	Chemical composition & max						Physical Properties min			Limiting Size (diameter or width) Across Plates)			Condition	Brinell No.
		C	Mn	Ni	Cr.	Mo.	Others	T.I t/sq	EI %	Izod ft.lbs					
19	1 percent chromium Molybdenum steel Suitable for tensile ranges of 45/80 tons according to the ruling section of the part	.35/.45	.50/.80	-	.90 1.50	.2/4	S & P .05 Si 0.10/.35	R. 45 S. 50 T. 55 U. 60 V. 65 W. 70 Y. 80	22 20 18 17 16 15 10	40 40 40 35 35 30 10	6" PS 32 4" - 36 2 1/2 - 41 2 1/2" - 46 1.1/8" - 50 1. 1/8 - 55 1" - 64	H & T H & T H & T H & T H & T H & T H & T	201/255 223/177 248/302 269/321 293/341 311/375 363/415		
24	1 1/2 percent Nickel-Chromium Molybdenum steel. Suitable for tensile ranges of 50/100 tons according to the ruling section of the part.	.35/45	.45/.7	1.3/ 1.8	.9/1.4	.2/35	Si. 10/35 S. P 0.05	S. 50 T. 55 U. 60 V. 65 W. 70 X. 75 Y. 80 Z.100	20 18 17 16 15 14 14 8	40 40 35 35 30 25 25 8	6" PS 36 6" - 41 4" - 46 2 1/2 - 50 1.1/8" - 55 1.1/8" - 59 1.1/8" - 64 1.1/8" - 80	H & T H & T H & T H & T H & T H & T H & T H & T	223/277 248/302 269/321 293/341 311/375 341/388 363/415 444 Min		
31	1 percent Carbon Chromium steel For parts of maximum hardness such as ball races.	.9/1.2	.3/.75	-	1/1.6	-	S.& P. .05 Si. .10/.35	-	-	-	-	-	-		
36A	3 percent Nickel- Chromium	.15	.3/.6	3/3.75	.6/1.1	-	Si .10/.35	55	15	35	-	-	-		
36B	Case- hardening steel	.12/.18	.3/.6	3/3.75	.6/1.1	-	-	65	13	30	-	-	-		
36C	3 percent Nickel Chromium. Molybdenum Case Hardening steel	.12/.18	.3/.6	3/3.75	.6/1.1	.1/.25	Si .10/.35	65	13	30	-	-	-		
41A	1-1/2 percent Chromium aluminium Molybdenum Nitriding steel	.25/.35	.65	.40	1.4/ 1.8	.1/.25	Si .1/.45 AL .9/1.3 S. & P. .05	R 45 S 50 T 55	20 19 17	40 40 35	6" 4" 2 1/2"	H & T H & T H & T	201/255 223/277 248/302		
41B	As above (EN, 41 A)	.35/.45	.65	.40	1.4/ 1.8	.1/.25	Si. .1/.45 S. & P. .05 AL .9/1.3	R. 45 S. 50 T. 55	20 19 17	40 40 35	-	H & T H & T H & T	201/255 223/277 248/302		
42	Carbon spring steel for oil Hardening and tempering. Suitable for laminated and coil springs.	.7/.85	.55/.75	-	-	-	Si. .1/.40 S. & P. .05	-	-	-	-	-	-		
47	1 percent Chromium-Vanadium spring steel for oil hardening and tempering.	.45/.55	.5/.8	-	.8/1.2	-	Va. .15 min Si. .50 S. & P. .05	-	-	-	-	-	-		
353	1.1/4 percent, Nickel Chromium Case Hardening steel	.20	.50/1.0	1.0/ 1.5	.75/ 1.25	.08/ .15	Si. .35 S. & P. .05	65	12	20	-	-	-		
354	1-3/4 percent Nickel-Chromium Molybdenum Case-Hardening steel.	20	.50/1.0	1.5/ 2.0	.75/ 1.25	.10/ .20	Si. .35 S. & P. .05	75	12	20	-	-	-		

SIGNS AND ABBREVIATIONS

H & T	Hardened and Tempered	CD	Cold drawn.
CR	Cold Rolled.	PS	Proof Stress.
N.	Normalised	<	Maximum

STAINLESS STEEL HOLLOW SECTION, SQUARE & RECTANGULAR TUBE WT. / MTR

h mm	b mm	t mm	Weight kg/m	A mm ²	I _y 10 ⁴ mm ⁴	W _y 10 ³ mm ³	i _y mm	I _z 10 ⁴ mm ⁴	W _z 10 ³ mm ³	i _z mm	I _v 10 ⁴ mm ⁴	W _v 10 ³ mm ³
30	20	1,00	0776	94	1,15	0,77	11,06	0,6135	0,61	8,08	1,29	1,01
30	20	1,20	0,925	110	1,33	0,89	11,00	0,7052	0,71	8,01	1,52	1,18
30	20	1,50	1,146	135	1,58	1,05	10,82	0,837	0,84	7,87	1,83	1,40
30	20	2,00	1,495	173	1,93	1,28	10,55	1,011	1,01	7,64	2,29	1,71
40	10	1,50	1,146	135	2,15	1,07	12,61	0,213	0,42	3,97	0,70	0,81
40	10	2,00	1,495	173	2,59	1,29	12,23	0,245	0,49	3,76	0,83	0,94
40	20	1,00	0,950	113	2,33	1,16	14,37	0,794	0,79	8,38	1,93	1,38
40	20	1,20	1,106	134	2,72	1,36	14,25	0,921	0,92	8,29	2,27	1,60
40	20	1,50	1,371	165	3,26	1,63	14,05	1,094	1,09	8,14	2,74	1,91
40	20	2,00	1,840	213	4,03	2,01	13,76	1,337	1,33	7,92	3,45	2,36
40	30	1,20	1,310	158	3,63	1,81	15,15	2,328	1,55	12,14	4,52	2,50
40	30	1,50	1,620	195	4,37	2,18	14,97	2,801	1,86	11,99	5,52	3,02
40	30	2,00	2,150	253	5,48	2,74	14,72	3,497	2,33	11,76	7,07	3,79
40	30	3,00	3,280	347	7,03	3,51	14,23	4,455	2,97	11,33	9,41	4,89
40	20	2,00	1,903	233	5,48	2,43	15,33	1,499	2,49	8,02	4,05	2,68
50	10	1,50	1,371	165	4,00	1,60	15,56	0,268	0,54	4,03	0,92	1,03
50	10	2,00	1,840	215	4,91	1,96	15,10	0,31	0,62	3,80	1,09	1,20
50	20	1,20	1,310	158	4,78	1,91	17,40	1,133	1,13	8,47	3,05	2,03
50	20	1,50	1,620	195	5,76	2,30	17,19	1,351	1,35	8,32	3,69	2,42
50	20	2,00	2,150	253	7,21	2,88	16,88	1,662	1,66	8,11	4,66	3,00
50	25	1,20	1,415	170	5,50	2,20	17,98	1,873	1,50	10,50	4,54	2,59
50	25	1,50	1,758	210	6,64	2,66	17,79	2,249	1,80	10,35	5,54	3,13
50	25	2,00	2,319	273	8,36	3,35	17,50	2,801	2,22	10,13	7,06	3,92
50	25	3,00	3,456	376	10,81	4,32	16,95	3,552	2,84	9,72	9,34	5,04
50	30	1,20	1,496	182	6,21	2,48	18,47	2,826	1,88	12,46	6,22	3,17
50	30	2,00	2,454	293	9,52	3,81	18,02	4,282	2,86	12,09	9,77	4,84
50	30	3,00	3,756	405	12,40	4,96	17,50	5,52	3,68	11,67	13,08	6,30
50	30	4,00	4,808	515	14,76	5,91	16,93	6,49	4,32	11,23	16,07	7,53
50	40	1,50	2,122	255	9,29	3,72	19,09	6,595	3,30	16,08	12,26	5,24
50	40	2,00	2,804	333	11,82	4,73	18,84	8,37	4,19	15,85	15,86	6,67
50	40	3,00	4,131	462	15,59	6,24	18,37	10,994	5,50	15,43	21,55	8,83
60	10	1,50	1,620	195	6,67	2,22	18,50	0,323	0,65	4,07	1,13	1,25
60	10	2,00	2,150	253	8,29	2,76	18,10	0,375	0,75	3,85	1,35	1,46
60	20	1,20	1,496	182	7,64	2,55	20,48	1,346	1,35	8,60	3,85	2,45
60	20	1,50	1,859	225	9,24	3,08	20,26	1,609	1,61	8,46	4,66	2,94
60	20	2,00	2,454	293	11,66	3,89	19,94	1,087	1,99	8,24	5,89	3,65
60	30	1,50	2,122	255	11,81	3,94	21,25	4,02	2,68	12,56	9,77	4,64
60	30	2,00	2,804	333	15,02	5,01	21,24	5,067	3,38	12,34	12,57	5,88
60	30	3,00	4,131	462	19,80	6,60	20,70	6,58	4,38	11,93	16,89	7,71
60	40	1,50	2,329	285	14,37	4,79	22,46	7,71	3,85	16,44	15,97	6,35
60	40	2,00	3,080	373	18,39	6,13	22,20	9,82	4,91	16,22	20,70	8,12
60	40	3,00	4,650	520	24,49	8,16	21,70	12,98	6,49	15,80	28,24	10,81
60	40	4,00	5,960	668	29,92	9,98	21,17	15,74	7,87	15,35	35,50	13,27
80	10	1,50	2,122	255	15,10	3,78	24,34	0,43	0,87	4,12	1,57	1,69
80	10	2,00	2,804	333	19,06	4,77	23,92	0,51	1,01	3,90	1,87	1,99
80	20	2,00	3,080	373	25,15	6,29	25,97	2,64	2,64	8,41	8,40	4,96
80	40	1,50	2,802	345	28,97	7,24	28,98	9,93	4,97	16,97	23,77	8,57
80	40	2,00	3,711	453	37,32	9,33	28,70	12,71	6,35	16,75	30,88	11,00
80	40	3,00	5,491	634	50,35	12,59	28,18	16,94	8,47	16,35	42,28	14,77
80	40	4,00	7,222	820	62,49	15,62	27,61	20,76	10,38	15,91	53,43	18,29
80	40	5,00	8,902	996	72,64	18,16	27,01	23,83	11,91	15,47	62,97	21,16
80	50	2,00	4,060	493	43,40	10,85	29,67	21,04	8,42	20,66	45,31	14,04
80	50	3,00	5,928	691	58,89	14,72	29,19	28,36	11,34	20,26	62,55	19,02
80	60	2,00	4,380	533	49,49	12,37	30,47	31,85	10,62	24,44	61,22	17,08
80	60	3,00	6,530	749	67,43	16,86	30,00	43,24	14,41	24,03	84,95	23,28
80	60	4,00	8,450	973	84,68	21,17	29,50	54,08	18,03	23,58	109,08	29,33
80	60	5,00	10,629	1188	99,73	24,93	28,57	63,44	21,15	23,11	130,81	34,56
100	20	2,00	3,711	453	46,11	9,22	31,90	3,29	3,29	8,52	10,94	6,26
100	40	2,00	4,380	533	65,32	13,06	35,01	15,60	7,80	17,11	41,47	13,89
100	40	3,00	6,530	749	88,91	17,78	34,45	20,91	10,45	16,71	56,88	18,73
100	40	4,00	8,450	973	111,46	22,29	33,85	25,78	12,89	16,28	72,04	23,31

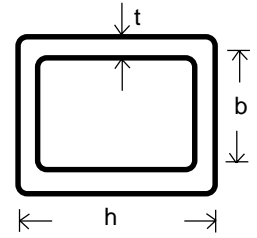

STAINLESS STEEL HOLLOW SECTION, SQUARE & RECTANGULAR TUBE WT. / MTR

h mm	b mm	t mm	Weight kg/m	A mm ²	I _y 10 ⁴ mm ⁴	W _y 10 ³ mm ³	i _y mm	I _z 10 ⁴ mm ⁴	W _z 10 ³ mm ³	i _z mm	I _v 10 ⁴ mm ⁴	W _v 10 ³ mm ³
100	40	5,00	10,629	1187	131,00	26,20	33,22	20,79	14,89	15,84	85,15	27,11
100	50	2,00	4,680	573	74,93	14,99	36,16	25,65	10,26	21,16	61,59	17,73
100	50	3,00	6,950	807	102,45	20,49	35,63	34,74	13,90	20,75	85,20	24,12
100	50	4,00	9,9090	1050	129,14	25,83	35,07	43,34	17,34	20,32	109,02	30,34
100	50	5,00	11,240	1283	152,69	30,54	34,500	50,72	20,29	19,88	130,28	35,68
100	50	6,00	13,490	1504	172,90	34,58	33,900	56,85	22,74	19,44	149,42	40,31
100	60	2,00	4,988	613	84,53	16,91	37,13	38,58	12,86	25,09	84,08	21,56
100	60	3,00	7,530	864	115,98	23,20	36,64	52,61	17,54	24,68	116,95	29,52
100	60	4,00	9,816	1126	146,82	29,36	36,11	66,16	22,05	24,24	150,60	37,38
100	60	5,00	12,395	1379	174,37	34,87	35,56	78,05	26,02	23,79	181,17	44,28
100	60	6,00	14,600	1619	198,43	36,69	35,01	88,25	29,42	23,35	209,30	50,40
100	80	2,00	5,625	693	103,74	20,75	38,69	73,83	18,46	32,64	134,59	29,24
100	80	3,00	8,388	978	143,07	28,61	38,25	101,60	25,40	32,23	188,34	40,33
100	80	4,00	11,050	1281	182,57	36,51	37,75	129,33	32,33	31,77	244,29	51,51
100	80	5,00	13,750	1569	217,75	43,55	37,25	153,89	38,47	31,32	296,06	61,54
100	80	6,00	16,220	1848	249,90	49,90	36,74	175,92	43,98	30,85	344,80	70,67
120	40	2,00	4,988	613	104,00	17,33	41,19	18,49	9,24	17,37	52,32	16,78
120	40	3,00	7,530	864	142,44	23,74	40,60	24,87	12,44	16,97	71,82	22,69
120	40	4,00	9,816	1128	180,27	30,05	39,98	30,85	15,43	16,54	91,07	28,33
120	60	2,00	5,624	693	131,85	21,97	43,62	45,31	15,10	25,57	107,88	26,05
120	60	3,00	8,388	979	181,83	30,30	43,10	61,99	20,66	25,16	150,24	35,76
120	60	4,00	11,050	1279	231,48	38,58	42,54	78,23	26,08	24,73	193,77	45,44
120	60	5,00	13,750	1570	276,60	46,10	41,97	92,67	30,89	24,30	233,50	54,00
120	60	6,00	16,220	1849	316,78	52,79	41,39	105,21	35,07	23,85	270,29	61,68
120	80	2,00	6,400	773	159,70	26,62	45,45	86,00	21,50	33,35	175,00	35,32
120	80	3,00	9,530	1094	221,21	36,87	44,97	118,68	29,67	32,94	245,28	48,87
120	80	4,00	12,400	1432	283,06	47,18	44,46	151,24	37,81	32,50	318,69	62,62
120	80	5,00	15,380	1761	340,09	56,68	43,95	180,97	45,24	32,06	387,05	75,05
120	80	6,00	17,500	2078	391,77	65,29	43,42	207,63	51,91	31,61	451,77	86,49
140	80	3,00	10,080	1208	321,22	45,89	51,57	135,76	33,94	33,52	304,37	57,40
140	80	4,00	13,312	1588	413,51	59,07	51,03	173,81	43,45	33,06	395,92	73,73
140	80	5,00	16,320	1952	497,66	71,09	50,49	208,06	52,01	32,65	481,43	88,57
150	50	3,00	9,530	1093	286,94	32,26	51,24	50,70	20,28	21,54	144,47	36,88
150	50	4,00	12,400	1435	367,37	48,98	50,60	63,88	25,55	21,10	185,30	46,69
150	50	5,00	15,580	1761	439,58	58,61	49,96	75,24	50,10	20,67	222,05	55,27
150	100	3,00	11,664	1381	442,28	58,97	56,59	237,87	47,57	41,50	486,59	78,22
150	100	4,00	15,424	1814	570,68	76,09	56,09	305,92	61,18	41,07	635,89	101,06
150	100	5,00	18,800	2239	691,68	92,22	55,58	369,57	73,91	40,63	776,96	122,14
150	100	6,00	22,560	2652	804,08	107,21	55,06	428,21	85,64	40,18	912,74	141,96
160	80	3,00	11,800	1323	445,39	55,67	58,02	152,84	38,21	33,99	365,07	65,94
160	80	4,00	15,030	1741	575,10	71,89	57,47	196,05	49,01	33,56	475,22	84,84
160	80	5,00	18,660	2143	694,27	86,78	56,92	235,14	58,78	33,12	578,31	102,10
160	80	6,00	21,200	2537	805,62	100,70	56,35	271,06	67,77	32,69	676,50	118,15
200	100	3,00	14,064	1667	886,97	88,70	72,94	305,58	61,12	42,81	723,49	105,29
200	100	4,00	18,624	2201	1153,24	115,32	72,39	395,22	79,04	42,37	946,81	136,48
200	100	5,00	22,400	2717	1402,13	140,21	71,84	478,01	95,60	41,94	1158,57	165,48
200	100	6,00	27,360	3226	1639,16	163,92	71,28	555,87	11,17	41,51	1363,22	192,96

Dimension	Tolerance	
External dimensions	<100mm 100 mm < 200 mm	+1% +0,8%
Thickness	t < 5mm t > 5mm	+10% 0.5 mm
Squareness	90=1	
Side convexity x 1		max. 0.8%
Side convexity x 2		min. 0,5 mm
External corner radius R		(1,8 x 2,1)t
Straightness	max 0,15%	
Twist V		2 mm+0,5 mm/m
Lenght l	< 5000 mm	+5mm/ - 0mm
Lenght l	< 5000 mm	+15mm/ - 0mm

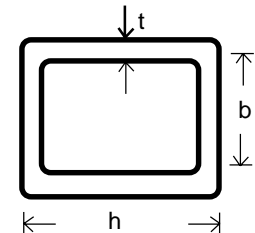

HOLLOW SECTION,

Grade:

- EN 1,4301 / AISI 304
- EN 1,4571 / AISI 316 Ti
- EN 1,4404 / AISI 316L

(also available as STALA 350 grade)

Duplex steel and high-alloy austenitic steel grades available to order

Surface finish grades

- hot or cold-rolled (lightly brushed)
- standard ground finish Grit 220 or 320
- to special order, Grit 80 -500 ground finish
- pickled finish
- other surface finishes to order

Dimensions of hollow sections

- wall thickness 1,2 to 6mm
- square hollow sections 25 x 25 mm to 150 x 150mm
- rectangular hollow sections 30 x 20 mm to 200 x 100 mm
- thick wall small-dimension sections such as 50 x 50 x 6.0 mm available to special order.

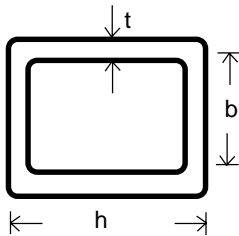

h = b mm	t mm	Weight kg/m	A mm ²	I _y 10 ⁴ mm ⁴	W _y 10 ³ mm ³	i _y mm	I _z 10 ⁴ mm ⁴	W _z 10 ³ mm ³
25	1,00	0,776	93	0,88	0,71	9,74	1,41	1,06
25	1,20	0,925	110	1,02	0,82	9,64	1,66	1,24
25	1,50	1,146	135	1,21	0,97	9,48	2,01	1,47
25	2,00	1,495	173	1,48	1,18	9,23	2,53	1,80
25	3,00	2,216	233	1,79	1,43	8,76	3,24	2,23
30	1,00	0,950	113	1,57	1,41	11,78	2,49	1,57
30	1,20	1,106	134	1,83	1,22	11,69	2,93	1,84
30	1,50	1,371	165	2,19	1,46	11,52	3,57	2,21
30	2,00	1,840	233	2,71	1,43	10,79	4,54	2,75
30	3,00	2,720	290	3,39	2,26	10,81	5,97	3,49
32	1,20	1,200	144	2,25	1,40	12,49	3,58	2,11
32	1,50	1,472	177	2,70	1,69	12,34	4,37	2,54
34	1,20	1,310	153	2,72	1,60	13,33	4,32	2,41
34	1,50	1,620	189	3,27	1,93	13,16	5,28	2,90
35	1,20	1,310	158	2,98	1,70	13,73	4,73	2,56
35	1,50	1,620	195	3,59	2,05	13,57	5,78	3,09
35	2,00	2,150	253	4,50	2,57	13,33	7,41	3,89
35	3,00	3,280	347	5,75	3,29	12,87	9,89	5,03
38	1,20	1,415	172	3,86	2,03	14,97	6,09	3,05
38	1,50	1,758	213	4,66	2,45	14,79	7,46	3,70
38	2,00	2,319	277	5,87	3,09	14,56	9,60	4,67
40	1,20	1,496	182	4,53	2,26	15,77	7,13	3,40
40	1,50	1,859	225	5,48	2,74	15,61	8,75	4,13
40	2,00	2,454	293	6,93	3,46	15,37	11,28	5,23
40	3,00	3,756	405	9,01	4,50	14,92	15,22	6,86
40	4,00	4,808	515	10,38	5,36	14,19	18,87	8,27
50	1,50	2,329	285	10,72	5,36	19,39	17,42	6,65
50	2,00	3,080	373	11,05	4,42	17,21	22,63	8,51
50	3,00	4,650	520	18,78	7,51	19,00	30,97	11,38
50	4,00	5,960	668	22,93	9,17	18,53	39,10	14,02
50	5,00	7,410	805	26,19	10,48	18,04	46,02	16,14
50	6,00	8,832	930	28,58	11,43	17,53	46,02	16,14
60	1,50	2,802	345	19,51	6,50	23,78	30,48	9,77
60	2,00	3,711	453	25,12	8,37	23,55	39,79	12,59
60	3,00	5,491	634	33,86	11,29	23,11	54,94	17,04
60	4,00	7,222	820	42,01	14,00	22,63	70,12	21,29
60	5,00	8,902	996	48,83	16,28	22,14	83,55	24,87
70	2,00	4,380	533	40,69	11,63	27,63	63,96	17,48
70	3,00	6,530	749	55,39	15,83	27,19	88,86	23,85
70	4,00	8,450	973	69,48	19,85	26,72	114,25	30,09
70	5,00	10,629	1188	81,73	23,35	26,23	137,21	35,50
80	2,00	4,988	613	61,66	15,41	31,72	96,34	23,16
80	3,00	7,530	864	84,51	21,13	31,27	134,44	31,80
80	4,00	9,816	1126	106,87	26,72	30,81	173,77	40,41
80	5,00	12,395	1379	126,81	31,72	30,32	209,87	48,04
80	6,00	14,600	1619	144,20	36,05	29,84	209,87	48,04
100	2,00	6,400	773	122,95	24,59	39,88	190,54	36,92
100	3,00	9,530	1094	170,16	34,02	39,44	267,49	51,15
100	4,00	12,400	1432	217,53	43,52	38,98	348,18	65,66
100	5,00	15,380	1761	261,13	52,23	38,51	423,66	78,83
100	6,00	17,500	2078	300,56	60,11	38,03	495,48	91,01
120	3,00	11,800	1323	299,97	50,00	47,62	467,87	75,09
120	4,00	15,030	1737	386,22	64,37	47,15	611,76	97,03
120	5,00	18,660	2144	467,08	77,85	46,67	747,87	117,27
120	6,00	21,200	2538	541,77	90,30	46,20	879,04	136,30
150	3,00	14,064	1668	597,61	79,68	59,86	924,81	119,61
150	4,00	18,624	2196	774,80	103,31	59,40	12115,26	1551,99
150	5,00	22,400	2717	943,78	125,80	58,94	14913,96	1892,47
150	6,00	27,360	3226	1102,87	147,00	58,47	17613,05	2214,37

ANSI FLANGES WEIGHTS (KGS)

N. B.	150 lbs		300 lbs		600 lbs		900 lbs	
	WN	SO	WN	SO	WN	SO	WIN	SO
1/2"	0.7	0.4	0.8	0.7	0.9	0.8	1.9	1.8
3/4"	0.9	0.7	1.4	1.2	1.6	1.4	2.7	2.5
1"	1.1	0.8	1.7	1.4	1.9	1.7	3.9	3.6
1 1/4"	1.5	1.2	2.2	1.8	2.6	2.1	4.5	4.1
1 1/2"	1.8	1.4	3.2	2.7	3.5	3.1	6.2	5.6
2"	2.7	2.2	3.6	3.2	4.7	3.8	11.3	10.3
2 1/2"	4.4	3.5	5.5	4.5	6.7	5.5	15.5	14.3
3"	5.1	4.1	7.3	6.1	8.7	7.3	15	12.3
3 1/2"	6.4	5.2	9	7.5	11.2	8.9	--	--
4"	7.5	5.6	11.9	10	18.3	15.8	24	20.5
5"	9	6.3	16	12.5	30.5	25	37.5	33.5
6"	11	7.8	20	16.2	37	29.5	50	43
8"	18.5	12.6	31	25	55	44	85	74
10"	25	18	44.3	35	91	71	125	105
12"	38	27.5	64	50	108	85	165	136
14"	51	37	88	72	150	96	198	158
16"	63	46	112	90	180	145	224	184
18"	71	50	138	115	240	175	320	258
20"	88	64	171	137	295	220	375	316
24"	120	90	240	210	363	315	680	608

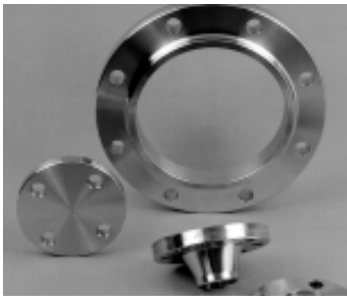

FORGED FLANGES DIMENSIONS

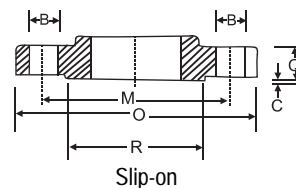
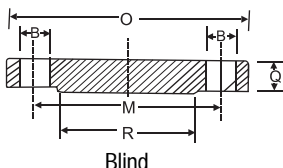
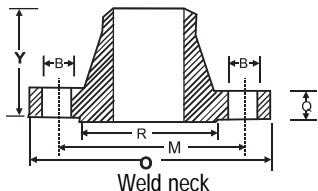

150 lbs

Normal pipe size (in mm)	Outside dia of flange	Minimum thickness of flange	Overall Length			bolt circle	No. and size of holes			O D of Raised face
			Welding neck	slip-on & socket welding	Lap joint					
	O	Q	Y			Dia.m	No.	B	R	
15	89	11.2	47.6	15.9	15.9	60.5	4	15	35	
20	98	12.7	52.4	15.9	15.9	70.0	4	15	43	
25	108	14.3	55.6	17.5	17.5	79.5	4	15	51	
32	117	15.9	57.2	20.6	20.6	89.0	4	15	64	
40	127	17.5	61.9	22.2	22.2	98.5	4	15	73	
50	152	19.1	63.5	25.4	25.4	120.5	4	19	92	
65	178	22.3	69.8	28.6	28.6	139.5	4	19	105	
80	190	23.9	69.8	30.2	30.2	152.5	4	19	127	
90	216	23.9	71.4	31.8	31.8	178.0	8	19	140	
100	229	23.9	76.2	33.3	33.3	190.5	8	19	157	
125	254	23.9	88.9	36.5	36.5	216.0	8	22	186	
150	279	25.4	88.9	39.7	39.7	241.5	8	22	216	
200	343	28.6	101.6	44.4	44.4	298.5	8	22	270	
250	406	30.2	101.6	49.2	49.2	362.0	12	25	324	
300	483	31.8	114.3	55.6	55.6	432.0	12	25	381	
350	533	35.0	127.0	57.2	79.4	476.0	12	29	413	
400	597	36.6	127.0	63.5	87.3	539.5	16	29	470	
450	635	39.7	139.7	68.3	96.8	578.0	16	32	533	
500	698	42.9	144.5	73.0	103.2	635.0	20	32	584	
600	813	47.7	152.4	82.6	111.1	749.5	20	35	692	

300 lbs

Normal pipe size (in mm)	Outside dia of flange	Minimum thickness of flange	Overall Length			bolt circle	No. and size of holes			O D of Raised face
			Welding neck	slip-on & socket welding	Lap joint					
	O	Q	Y			Dia.m	No.	B	R	
15	95	14.3	52.4	22.2	22.2	66.5	4	15	35	
20	117	15.9	57.2	25.4	25.4	82.5	4	19	43	
25	124	17.5	61.9	27.0	27.0	89.5	4	19	51	
32	133	19.1	65.1	27.0	27.0	98.5	4	19	64	
40	156	20.7	68.3	30.2	30.2	114.5	4	22	73	
50	165	22.3	69.8	33.3	33.3	127.0	8	19	92	
65	190	25.4	76.2	38.1	38.1	149.0	8	22	105	
80	210	28.6	79.4	42.9	42.9	168.0	8	22	127	
90	229	30.2	81.0	44.5	44.5	184.0	8	22	140	
100	254	31.8	85.7	47.6	47.6	200.0	8	22	157	
125	279	35.0	98.4	50.8	50.8	235.0	8	22	186	
150	313	36.6	98.4	52.4	52.4	270.0	12	22	216	
200	381	41.3	111.1	61.9	61.9	330.0	12	25	270	
250	444	47.7	117.5	66.7	95.3	387.5	16	29	324	
300	521	50.8	130.2	73.0	101.6	451.0	16	32	381	
350	584	54.0	142.9	76.2	111.1	514.5	20	32	413	
400	648	57.2	146.0	82.6	120.7	571.5	20	35	470	
450	711	60.4	158.8	88.9	130.2	628.5	24	35	584	
500	775	63.5	161.9	95.2	139.7	686.0	24	35	692	
600	914	69.9	168.3	106.4	152.4	813.0	24	41	692	

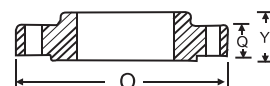
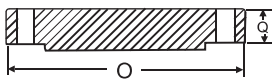
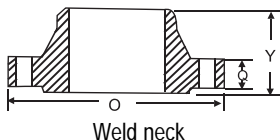

600 lbs

Normal pipe size (in mm)	Outside dia of flange	Minimum thickness of flange	Overall Length			bolt circle	No. and size of holes			O D of Raised face
			Welding neck	slip-on & socket welding	Lap joint					
	O	Q	Y			Dia.m	No.	B	R	
15	95	14.3	52.4	22.2	22.2	66.5	4	15	35	
20	117	15.9	57.2	25.4	25.4	82.5	4	19	43	
25	124	17.5	61.9	27.0	27.0	89.5	4	19	51	
32	133	20.7	66.7	28.6	28.5	98.5	4	19	64	
40	156	22.3	69.8	31.8	31.8	114.5	4	22	73	
50	165	25.4	73.0	36.5	36.5	127.0	8	19	92	
65	190	28.6	79.4	41.3	41.3	149.0	8	22	105	
80	210	31.8	82.6	46.0	46.0	168.0	8	22	127	
90	229	35.0	85.7	49.2	49.2	184	8	25	140	
100	273	38.1	101.6	54.0	54.0	216.0	8	25	157	
125	330	44.5	114.3	60.3	60.3	266.5	8	29	186	
150	356	47.7	117.5	66.7	66.7	292.0	12	29	216	
200	419	55.6	133.4	76.2	76.2	349.0	12	32	270	
250	508	63.5	152.4	85.7	115.1	432.0	16	35	324	
300	559	66.7	155.6	92.1	111.1	489.0	20	35	381	
350	603	69.9	165.1	93.7	117.5	527.0	20	38	413	
400	686	76.2	177.8	106.4	127.0	603.0	20	41	470	
450	743	82.6	184.2	117.6	139.7	654.0	20	45	533	
500	813	88.9	190.5	127.0	165.1	724.0	24	45	584	
600	940	101.6	203.2	139.7	184.2	838.0	24	51	692	

900 lbs

Normal pipe size (in mm)	Outside dia of flange	Minimum thickness of flange	Overall Length			bolt circle	No. and size of holes			O D of Raised face
			Welding neck	slip-on & socket welding	Lap joint					
	O	Q	Y			Dia.m	No.	B	R	
15	121	22.3	60.3	31.8	31.8	82.5	4	22	35	
20	130	25.4	69.8	34.9	34.9	89.0	4	22	43	
25	149	28.6	73.0	41.3	41.3	101.5	4	25	51	
32	159	28.6	73.0	41.3	41.3	111.0	4	25	64	
40	178	31.8	82.6	44.4	44.4	124.0	4	29	73	
50	216	38.1	101.6	57.2	57.2	165.0	8	25	92	
65	244	41.3	104.8	63.5	63.5	190.5	8	29	105	
80	241	38.1	101.6	54.0	54.0	190.5	8	25	127	
100	292	44.5	114.3	69.8	69.8	235.0	8	32	157	
125	349	50.8	127.0	79.4	79.4	279.5	8	35	186	
150	381	55.6	139.7	85.7	85.7	317.5	12	32	216	
200	470	68.5	161.5	101.8	114.3	393.5	12	38	270	
250	546	69.9	184.2	108.0	127.0	470.0	16	38	324	
300	610	79.4	200.0	117.5	142.9	533.5	20	38	381	
350	641	85.8	212.7	130.2	155.6	559.0	20	41	413	
400	705	88.9	215.8	133.4	165.1	616.0	20	45	470	
450	787	101.6	228.6	152.4	190.5	686.0	20	51	533	
500	857	108.0	247.6	158.8	209.6	749.5	20	54	584	
600	1041	139.7	292.1	203.2	266.7	901.5	20	67	692	

CLASS 1500 FLANGES - METRIC

N.B.	A	B	C	D	E	F	G	H	J	K	L	M	N	O	P	R	T	No.of Holes
15	121	22.2	6.4	35	32	38	22.4	9.5	21.3	23.5	60	22	32	23.0	82.6	3.0	22.2	4
20	130	25.4	6.4	43	35	44	27.7	11.0	26.7	29.0	70	25	35	28.0	88.9	3.0	22.2	4
25	149	28.6	6.4	51	41	52	34.5	12.5	33.4	36.0	73	29	41	35.0	101.6	3.0	25.4	4
32	159	28.6	6.4	64	41	64	43.2	14.5	42.2	44.5	73	30	41	43.5	111.1	5.0	25.4	4
40	178	31.8	6.4	73	44	70	49.5	16.0	48.3	50.5	83	32	44	50.0	123.8	6.5	28.6	4
50	216	38.1	6.4	92	57	105	62.0	17.5	60.3	63.5	102	38	57	62.5	165.1	8.0	25.4	8
65	244	41.3	6.4	105	64	124	74.7	19.0	73.0	76.0	105	48	64	75.0	190.5	8.0	28.6	8
80	267	47.6	6.4	127	73	133	--	--	88.9	92.0	117	51	73	91.5	203.2	9.5	31.8	8
100	311	54.0	6.4	157	91	162	--	--	114.3	118.0	124	57	91	117.0	241.3	11.0	34.9	8
125	375	73.0	6.4	186	105	197	--	--	141.3	145.0	156	64	105	145.0	292.1	11.0	41.3	8
150	394	82.6	6.4	216	119	229	--	--	168.3	171.0	171	70	119	171.0	317.5	12.5	38.1	12
200	483	92.1	6.4	270	143	292	--	--	219.1	222.0	213	76	143	222.0	393.7	12.5	44.4	12
250	584	108.0	6.4	324	159	368	--	--	273.0	276.0	254	84	178	277.0	482.6	12.5	50.8	12
300	673	123.8	6.4	381	181	451	--	--	323.9	329.0	283	92	219	328.0	571.5	12.5	54.0	16
350	749	133.4	6.4	413	--	495	--	--	356.6	--	298	--	241	360.0	635.0	12.5	60.3	16
400	826	146.1	6.4	470	--	552	--	--	406.4	--	311	--	260	411.0	704.8	12.5	6.7	16
450	914	161.9	6.4	533	--	597	--	--	457.2	--	327	--	276	462.0	774.7	12.5	73.0	16
500	984	178.0	6.4	584	--	641	--	--	508.0	--	356	--	292	514.0	831.8	12.5	79.4	16
600	1168	203.0	6.4	692	--	762	--	--	609.6	--	406	--	330	616.0	990.6	12.5	92.0	16

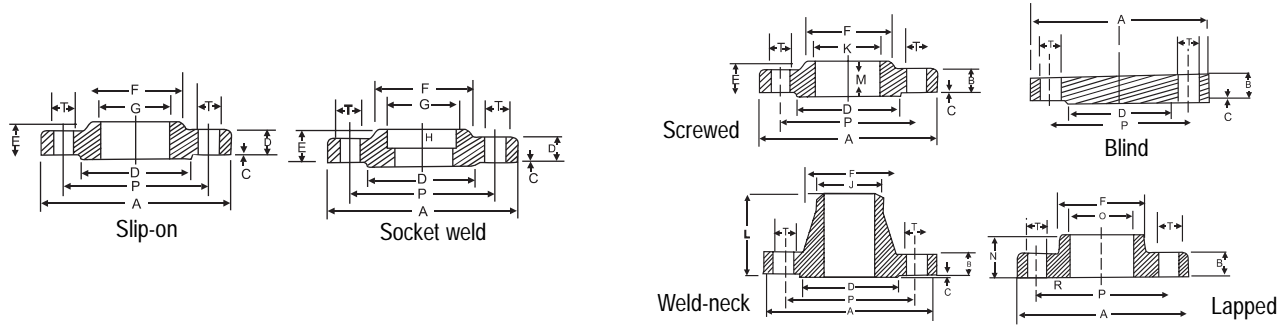

CLASS 2500 FLANGES - METRIC

N.B.	A	B	C	D	E	F	G	H	J	K	L	M	N	O	P	R	T	No of Holes
15	133	30.2	6.4	35	40	43	--	--	21.3	23.5	73	29	40	23.0	88.9	3.0	22.2	4
20	140	31.7	6.4	43	43	51	--	--	26.7	29.0	79	32	43	28.0	95.2	3.0	22.2	4
25	159	34.9	6.4	51	48	57	--	--	33.4	35.0	89	35	48	35.0	107.9	3.0	25.4	4
32	184	38.1	6.4	64	52	73	--	--	42.2	44.5	95	38	52	43.5	130.2	5.0	28.6	4
40	203	44.4	6.4	73	60	79	--	--	48.3	50.5	111	44	60	50.0	146.0	6.5	31.8	4
50	235	50.8	6.4	92	70	95	--	--	60.3	63.5	127	51	70	62.5	171.4	8.0	28.6	8
65	267	57.1	6.4	105	79	114	--	--	73.0	76.0	143	57	79	75.5	196.8	8.0	31.8	8
80	305	66.7	6.4	127	92	133	--	--	88.9	92.0	168	64	92	91.5	228.6	9.5	34.9	8
100	356	76.2	6.4	157	108	165	--	--	114.3	118.0	190	70	108	117.0	273.0	11.0	41.3	8
125	419	92.1	6.4	186	130	203	--	--	141.3	145.0	229	76	130	145.0	323.8	11.0	47.6	8
150	483	108.0	6.4	216	152	235	--	--	168.3	171.0	273	83	152	171.0	368.3	12.5	54.0	8
200	552	127.0	6.4	270	178	305	--	--	219.1	222.0	318	95	178	222.0	438.1	12.5	54.0	12
250	673	165.1	6.4	324	229	375	--	--	273.0	276.0	419	108	229	277.0	539.7	12.5	66.7	12
300	762	184.1	6.4	381	254	441	--	--	323.9	329.9	464	121	254	328.0	619.1	12.5	73.0	12

*Minimum length.

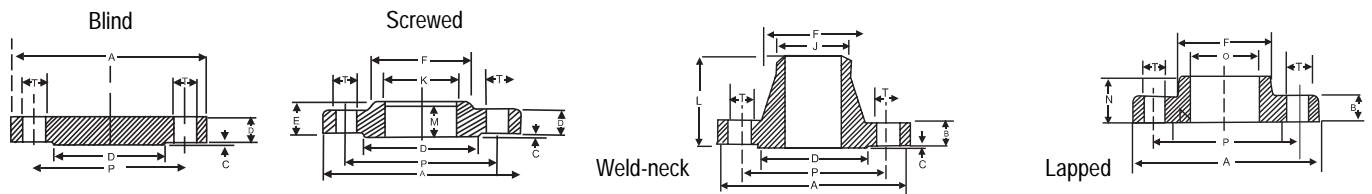

DIMENSIONAL TOLERANCES FOR FORGED STEEL FLANGES

Threaded, lap joint, slip-on and Blind Flanges
ANSI B 16.5

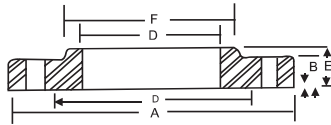

Outside Diameter (A)	When O.D. is 24" or less	$\pm 1/16^{**}$	Outside Dia. of Hub (F)	12" and smaller	$+3/32^{**}-1/16^{**}$
	When O. D is over 24"	$\pm 1/8^{**}$		Over 12"	$\pm 1/8^{**}$
Inside Diameter (D)	Threaded	Within limits on Boring gauge	Drilling	Bolt Circle	$\pm 1/16^*$
	Slip on and Lap Joint	10" and smaller $+ 1/32", -0"$ 12" and larger $+ 1/16"-0"$		Bolt hole spacing	$\pm 1/32^*$
Diameter of Contact Face (C)	1/16 Raised Face	$\pm 1/32"$	Overall Height (E)	On flanges 18" and smaller	$+1/8^{**}-1/32^{**}$
	1/4 Raised Face, Tongue and Groove of male and Female	$\pm 1/64"$		On flanges larger than 13"	$+3/15^{**}-1/16^{**}$
Diameter of Counter bore	Same as for inside diameter		Thickness (E)	13" and smaller	$41/8"-0"$
				Over 18"	$+ 3/16"-0"$
				Where allowance has been left On face for finish: All sizes $+ 1/8^{**}-1/16^{**}$	

Welding neck flanges
ANSI B 16.5

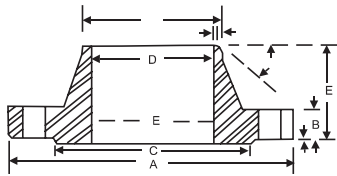

This tolerance not covered by
ANSI B 16.5

Outside Diameter (A)	When O. D. is 24: or less	$\pm 1/16^{**}$	Drilling	Bolt Circle	$\pm 1/16^*$
	When O. D. is over 24"	$\pm 1/8^{**}$		Bolt hole spacing	$\pm 1/32^*$
smaller inside Diameter (D)	10" and smaller	$\pm 1/32"$	Eccentricity between $1/2"$ and smaller $2 1/2"$ and	bolt circle diameter	$1/32"$ max
12" to 18"	$\pm 1/16$	and machined facing diameter		3" and larger diameter	$1/16"$ max
	Over 18"	$+ 1/8-1/16"$	Width of Land	All sizes	$\pm 1/32"$
Diameter of Contact Face (C)	1/16" Raised Face	$\pm 1/32"$	Angle of Hub Bevel	All Sizes	$\pm 2 1/2"$
	1/4" Raised face, Tongue and Groove, or Male and Female	$\pm 1/64"$		18" and smaller	$\pm 1/16$
Diameter of Hub at Point of Welding (G)	5" and smaller	$+3/32"-1/32"$	Overall Height (E)	12" and larger \pm	$\pm 1/8"$
	5" and larger	$+5/32"-1/32$		10" and smaller	$+ 1/8"-0"$
Diameter of Hub at Base (F)	When "F" is 24" and smaller	$\pm 1/8^{**}$	Thickness (E)	Over 18"	$+ 3/16"-0"$
	When "F" is over 24"	$\pm 1/8$		Where allowance has been left on face for Finish, All size	$+1/8^{**}-1/16^{**}$

BS 10 PIPE FLANGES

N.B. Size	Table	Dia of Flange A	Bore of Slip-on B	Thickness of Flange C	Pitch circle Dia D	Dia of Bolt Holes E	No. of Bolts
1/2"	D	3 3/4	0.88	3/16	2 5/8	9/16	4
	E	3 3/4	0.88	1/4	2 5/8	9/16	4
	F	3 3/4	0.88	3/8	2 5/8	9/16	4
	H	4 1/2	0.88	1/2	3 1/4	11/16	4
3/4"	D	4	1.09	3/16	2 7/8	9/16	4
	E	4	1.09	1/4	2 7/8	9/16	4
	F	4	1.09	3/8	2 7/8	9/16	4
	H	4 1/2	1.09	1/2	3 1/4	11/16	4
1"	D	4 1/2	1.36	3/16	3 1/4	9/16	4
	E	4 1/2	1.36	9/32	3 1/4	9/16	4
	F	4 3/4	1.36	3/8	3 7/16	11/16	4
	H	4 3/4	1.36	9/16	3 7/16	11/16	4
1.1/4"	D	4 3/4	1.70	1/4	3 7/16	9/16	4
	E	4 3/4	1.70	5/16	3 7/16	9/16	4
	F	5 1/4	1.70	1/2	3 7/8	11/16	4
	H	5 1/4	1.70	11/16	3 7/8	11/16	4
1.1/2"	D	5 1/4	1.95	1/4	3 7/8	9/16	4
	E	5 1/4	1.95	11/32	3 7/8	9/16	4
	F	5 1/2	1.95	1/2	4 1/8	11/16	4
	H	5 1/2	1.95	11/16	4 1/8	11/16	4
2"	D	6	2.44	5/16	4 1/2	11/16	4
	E	6	2.44	3/8	4 1/2	11/16	4
	F	6 1/2	2.44	5/8	5	11/16	4
	H	6 1/2	2.44	3/4	5	11/16	4
2.1/2"	D	6 1/2	2.94	5/16	5	11/16	4
	E	6 1/2	2.94	13/32	5	11/16	4
	F	7 1/4	2.94	5/8	5 3/4	11/16	8
	H	7 1/4	2.94	3/4	5 3/4	11/16	8
3"	D	7 1/4	3.57	3/8	5 3/4	11/16	4
	E	7 1/4	3.57	7/16	5 3/4	11/16	4
	F	8	3.57	5/8	6 1/2	11/16	8
	H	8	3.57	7/8	6 1/2	11/16	8
3.1/2"	D	8	4.07	3/8	6 1/2	11/16	4
	E	8	4.07	15/32	6 1/2	11/16	8
	F	8 1/2	4.07	3/4	7	11/16	8
	H	8 1/2	4.07	7/8	7	11/16	8
4"	D	8 1/2	4.57	3/8	7	11/16	4
	E	8 1/2	4.57	1/2	7	11/16	8
	F	9	4.57	3/4	7 1/2	11/16	8
	H	9	4.57	1	7 1/2	11/16	8
5"	D	10	5.56	1/2	8 1/4	11/16	8
	E	10	5.66	9/16	8 1/4	11/16	8
	F	11	5.66	7/8	9 1/4	11/16	8
	H	11	5.66	1 1/2	9 1/4	11/16	8

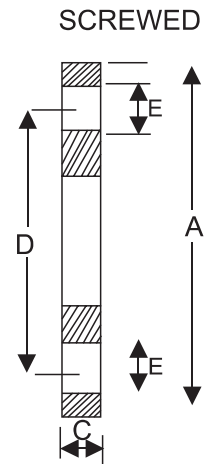
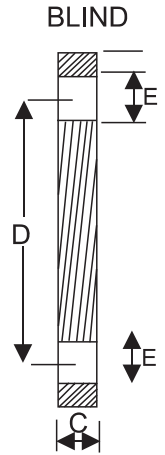
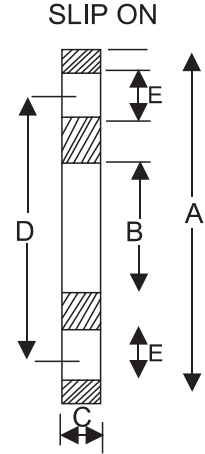

BS 10 PIPE FLANGES

N.B. Size	Table	Dia of Slip-on A	Bore of Flange B	Thickness of Flange C	Pitch circle Dia D	Dia of Bolt Holes E	No. of Bolts
6"	D	11	6.72	1/2	9 1/4	11/16	8
	E	11	6.72	11/16	9 1/4	7/8	8
	F	12	6.72	7/8	10 1/4	7/8	12
	H	12	6.72	1 1/8	10 1/4	7/8	12
8"	D	13 1/4	8.72	1/2	11 1/2	11/16	8
	E	13 1/4	8.72	3/4	11 1/2	7/8	8
	F	14 1/2	8.72	1	12 3/4	7/8	12
	H	14 1/2	8.72	1 1/4	12 3/4	7/8	12
10"	D	16	10.88	5/8	14	7/8	8
	E	16	10.88	7/8	14	7/8	12
	F	17	10.88	11/8	15	1	12
	H	17	10.88	13/8	15	1	12
12"	D	18	12.88	3/4	16	7/8	12
	E	18	12.88	1	16	1	12
	F	19 1/4	12.88	1 1/4	17 1/4	1	16
	H	21 3/4	12.88	1 7/8	19 1/2	1 1/8	16
14"	D	22 3/4	16.16	7/8	20 1/2	1	12
	E	22 3/4	16.16	1 1/4	20 1/2	1	12
	F	24	16.16	1 5/8	21 3/4	1 1/8	16
	H	24	16.16	2 1/8	21 3/4	1 1/4	16
16"	D	25 1/4	16.18	1	23	1	12
	E	22 3/4	16.16	1 1/4	21 3/4	1	12
	F	24	16.16	1 5/8	21 3/4	1 1/8	20
	H	24	16.16	2 1/8	21 3/4	1 1/8	20
18"	D	25 1/4	18.18	1	23	1	12
	E	25 1/4	18.18	1 3/4	23	1	16
	F	26 1/2	18.18	1 3/4	24	1 1/4	20
	H	26 1/2	18.18	2 3/8	24	1 1/4	20
20"	D	27 3/4	20.20	1 1/8	25 1/4	1	16
	E	27 3/4	20.20	1 1/2	25 1/4	1	16
	F	29	20.20	2	26 1/2	1 1/4	24
	H	29	20.20	2 5/8	26 1/2	1 1/4	24
22"	D	30	22.22	1 1/8	27 1/2	1 1/8	16
	E	30	22.22	1 3/4	27 1/2	1 1/8	16
	F	31	22.22	2 1/8	28 1/2	1 1/4	24
	H	31	22.22	2 3/4	28 1/2	1 1/4	24
24"	D	32 1/2	24.25	1 1/4	29 3/4	1 1/8	16
	E	32 1/2	24.25	1 7/8	29 3/4	1 1/4	16
	F	33 1/2	24.25	2 1/4	30 3/4	1 3/8	24
	H	33 1/2	24.25	3	30 3/4	1 3/8	24

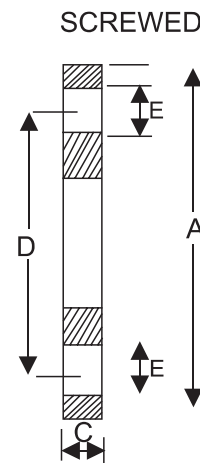
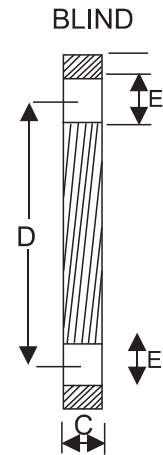
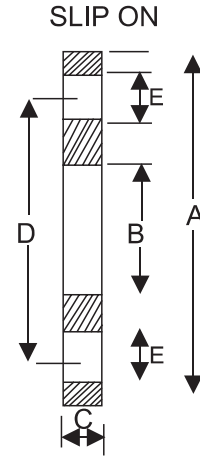

BUTT WELDED PIPE FITTINGS

Nom.	Pipe	Wall thickness								Radius					Length		H	D	h
		5S	10S	40S	80S	1D	1.5D	2D	3D	A	B	C	E	G	L	L			
Bore inch	O.D																		
1/2	21.34	1.65	2.11	2.77	3.73	12.7	19.06	25.4	38.1	12.7	15.9	25.4	25.4	34.9	50.8	76.2	50.8	42	8
3/4	26.67	1.65	2.11	2.87	3.91	19.05	28.57	38.10	57.15	19.05	11.1	28.6	25.4	42.8	50.8	76.2	50.8	52	8
1	33.40	1.65	2.77	3.38	4.55	25.4	38.1	50.8	76.2	52.4	22.2	38.1	38.1	50.8	50.8	101.6	50.8	65	10
1 1/4	42.16	1.65	2.77	3.56	4.85	31.75	47.6	63.5	95.25	31.75	25.0	47.6	38.1	63.1	50.8	101.6	50.8	72	12
1 1/2	48.26	1.65	2.77	3.68	5.08	38.1	57.15	76.2	114.3	38.10	28.6	57.2	38.1	73.0	50.8	101.6	63.5	82	12
2	60.32	1.65	2.77	3.91	5.54	50.8	76.2	101.6	152.4	50.8	34.0	63.5	38.1	92.0	63.5	152.4	76.2	98	16
2 1/2	73.02	2.11	3.05	5.16	7.01	63.5	95.25	127.0	190.5	63.5	44.0	76.2	38.1	104.8	63.5	152.4	88.9	118	15
3	88.90	2.11	3.05	5.49	7.62	76.2	114.30	152.4	228.6	76.2	50.8	85.7	50.8	127.0	63.5	152.4	88.9	130	18
3 1/2	101.60	2.11	3.05	5.74	8.08	88.9	133.35	177.8	266.7	88.9	57.2	95.3	63.5	139.7	76.2	152.4	101.6	140	18
4	114.30	2.11	3.05	6.02	8.56	101.6	152.4	203.2	304.8	101.6	63.5	104.8	63.5	157.2	76.2	152.4	101.6	168	20
5	141.30	2.77	3.40	6.55	9.52	127.0	190.5	254.0	381.0	127.0	82.6	123.8	76.2	185.7	76.2	203.2	127.0	188	25
6	168.27	2.77	3.40	7.11	10.97	152.4	228.6	304.8	457.2	152.4	95.3	142.7	88.9	215.9	88.9	203.2	139.7	215	25
8	219.07	2.77	3.76	8.18	12.7	203.2	304.8	406.4	609.6	203.2	127.0	177.5	101.6	270.0	101.6	203.2	152.4	270	30
10	273.05	3.40	4.19	9.27	12.7	254.0	381.0	508.0	762.0	254.0	158.7	275.9	127.0	324.0	127.0	254.0	177.8	330	35
12	323.85	3.96	4.57	9.52	12.7	304.8	457.2	609.6	914.4	340.8	190.5	254.0	152.4	381.0	152.4	254.0	203.2	400	40
14	355.60	3.96	4.76	9.52	12.7	355.6	533.4	711.2	1066	355.6	222.2	280.0	165.1	412.8	152.4	305.0	330.2	470	40
16	406.40	4.19	4.76	9.52	12.7	406.4	609.6	812.8	1219	406.4	254.0	340.8	177.8	470.0	152.4	305.0	355.6	535	40
18	457.20	4.19	4.76	9.52	12.7	457.2	685.8	914.4	1372	457.2	285.7	343.0	203.2	533.4	152.4	305.0	381.0	535	40
20	508.00	4.76	5.54	9.52	12.7	508.0	762.0	1016	1524	508.0	317.6	381.0	228.6	584.2	152.4	305.0	508.0	642	40
24	609.60	5.54	6.35	9.52	12.7	609.6	914.4	1219	1829	-	881.00	431.8	266.7	698.5	152.4	305.0	508.0	693	40

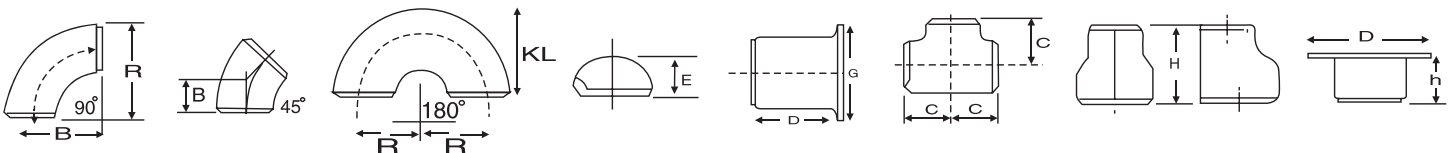

TABLE TOLERANCES (ANSI B 16.9)

All Fittings	Nominal Pipe size (NPS)	Outside Diameter at Bore (1), (2) D	Inside diameter at End (1), (2), (3)	Wall Thickness (3)	90 deg. and 45 deg. elbows and Tees	Reducers & Lap Joints Stub Ends	Caps	180 deg Returns			Lap Joint Stub Ends		
								Center to end Dimension A,B,C,M	Center to Overall Length F,H	Overall Length E	Center to Center Dimension O	Back to Face Dimension K	Alignment of ends U
	1/2 to 2/12		0.8		2	2	4	7	7	1	+0.1	+0.1	See Table 7 for limiting dimensions
	3 to 3/12		1.6		2	2	4	7	7	1	+0.1	+0.1	
	4	+2	1.6	Not Less than 87.5% of nominal thickness	2	2	4	7	7	1	+0.1	+0.1	
	5 to 6	-3	1.6		2	2	7	7	7	1	+0.1	+0.2	
	8	+4	1.6		2	2	7	7	7	1	+0.1	+0.2	
	10	+4	3.2		2	2	7	10	7	2	+0.2	+0.2	
	12 to 18	+4	3.2		2	2	7	10	7	2	+0.2	+0.2	
	20 to 24	+6	4.8		3	3	7	10	7	2	+0.2	+0.2	
	26 to 30	+7	4.8		3	3	10	10	7	2	
	32 to 48	+7	4.8		5	5	10	

Nominal Pipe Size (NPS)	Angularity - Tall	
	Off Angle Q	Off Plane P
1/2 to 4	1	2
5 to 8	2	4
10 to 12	3	5
14 to 16	3	7
18 to 24	4	10
26 to 30	5	10
32 to 42	5	13
44 to 48	5	20

GENERAL NOTE : Dimensions are in millimeters (except NPS) tolerances are equal plus minus except as noted.

NOTES :

- 1) Out of round is the sum of absolute values of plus and minus tolerance.
- 2) This tolerance may be exceed in localized area of formed fittings where increased wall thickness is required to meet design requirements of para 2.2.
- 3) The inside diameter and the nominal wall thickness at ends are to be specified by the purchaser.
- 4) Unless otherwise specified by the purchaser, these tolerances apply to the nominal inside diameter, which equals the difference between the nominal outside diameter and twice the nominal wall thickness.

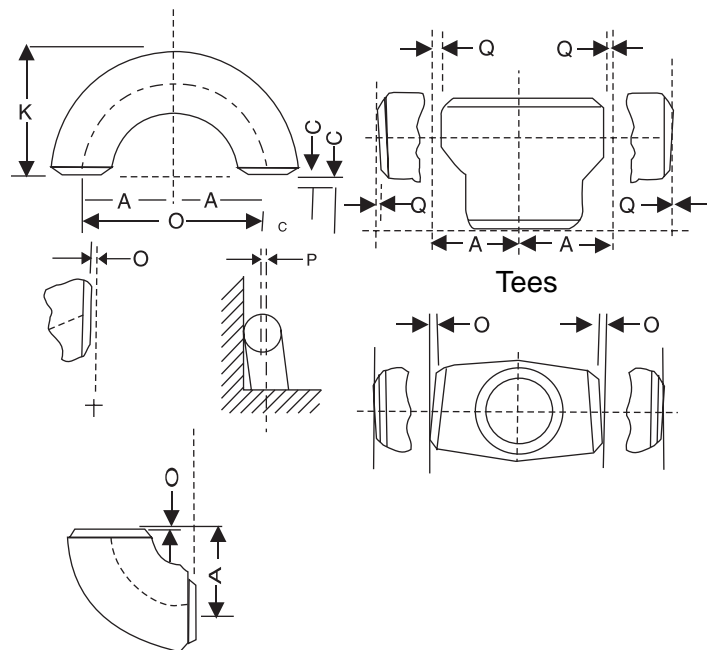

SOCKET WELD PIPE FITTINGS - STANDARD DIMENSIONS

Nominal Pipe Size		inch	1/8	1/4	3/8	1/2	3/4	1	1 1/4	1 1/2	2	2 1/2	3	4
		mm	3.2	6.4	9.5	12.7	19.0	25.4	31.7	38.1	50.8	63.5	76.2	101.6
Length	A	mm	25.4	25.4	28.6	35.0	38.1	44.4	47.6	50.8	63.5	63.5	69.9	76.2
Centre to Face	B	mm	20.6	20.6	24.6	28.6	33.3	38.1	44.4	50.8	60.3	76.2	85.7	106.3
Cap Length	C	mm	17.46	17.46	19.05	22.23	25.4	26.99	30.16	31.75	38.10	38.10	44.45	47.63
Out Side	D	mm	19.0	22.2	25.4	31.7	38.1	44.5	57.2	63.5	76.2	92.1	108.0	139.7
Diameter	E	mm	22.2	22.2	25.4	33.3	38.1	46.0	55.5	62.0	75.4	92.0	109.5	146.0
Socket Bore	F	mm	10.7	14.1	17.5	21.7	27.0	33.8	42.5	48.6	61.1	74.0	89.8	115.4
Depth of Socket	G/H MIN	mm	9.5	9.5	9.5	9.5	12.7	12.7	12.7	12.7	15.9	15.9	15.9	19.0
	G MAX	mm	9.5	9.5	11.1	12.7	14.3	15.9	17.5	19.0	22.2	22.2	25.4	28.6
	H MAX	mm	9.5	9.5	11.1	12.7	14.3	15.9	17.5	19.0	22.2	28.6	35.0	39.7
Centre to Socket	J	mm	11.1	11.1	13.5	15.8	19.0	22.2	27.0	31.7	38.1	41.2	57.1	66.6
Back face	K	mm	8.0	8.0	8.0	11.1	12.7	14.3	17.4	20.6	25.4	28.6	31.7	41.2
Centre to face	L	mm	17.46	19.0	19.0	22.2	25.4	28.6	33.3	35.0	42.8	52.4	63.5	79.3
Wall Thk minimum		mm	3.18	3.30	3.51	4.09	4.27	4.98	5.28	5.54	6.05	7.65	8.31	9.35
Bore		mm	6.45	8.86	12.14	15.42	20.55	26.26	34.67	40.51	52.12	61.95	77.17	101.50

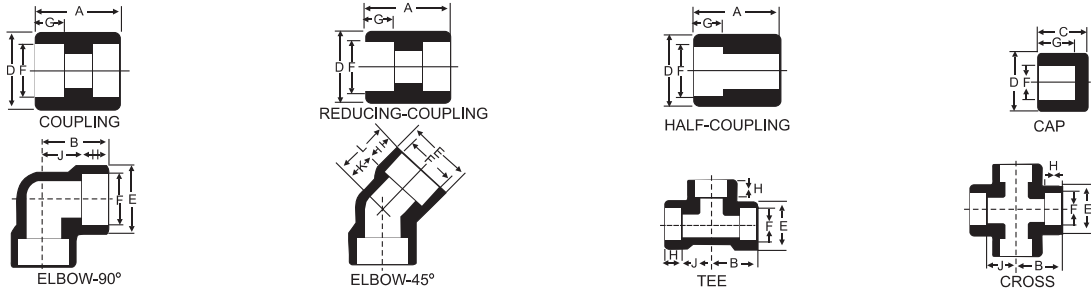

Nominal Pipe Size		inch.	1/8	1/4	3/8	1/2	3/4	1	1 1/4	1 1/2	2	2 1/2	3	4
		mm	3.2	6.4	9.5	12.7	19.0	25.4	31.7	38.1	50.8	63.5	76.2	101.6
Face to Face Length	A	mm	31.7	35.0	38.1	47.6	50.8	60.3	66.7	79.4	85.7	92.1	108.0	120.7
	B	mm	15.9	17.5	19.0	23.8	25.4	30.2	33.3	39.7	42.9	46.0	54.0	60.3
	C	mm	19.0	25.4	25.4	31.7	36.5	41.3	44.5	44.5	47.6	60.3	65.1	68.3
Face to Centre Length	D	mm	20.6	24.6	28.6	33.3	38.1	44.4	50.8	60.3	63.5	82.5	95.2	114.3
	E	mm	15.9	19.0	22.2	28.6	35.0	44.5	57.2	63.5	76.2	92.1	108.0	139.7
Outside Diameter Length of Thread	F	mm	22.2	25.4	33.3	38.1	46.0	55.5	62.0	75.4	84.1	101.6	120.6	152.4
	G	mm	6.35	8.13	9.14	10.92	12.70	14.73	17.02	17.78	19.05	23.67	25.81	27.79
45° Elbow Face to Centre	H	mm	17.5	19.0	22.2	25.4	28.6	33.3	35.0	42.8	43.6	52.4	63.5	79.3

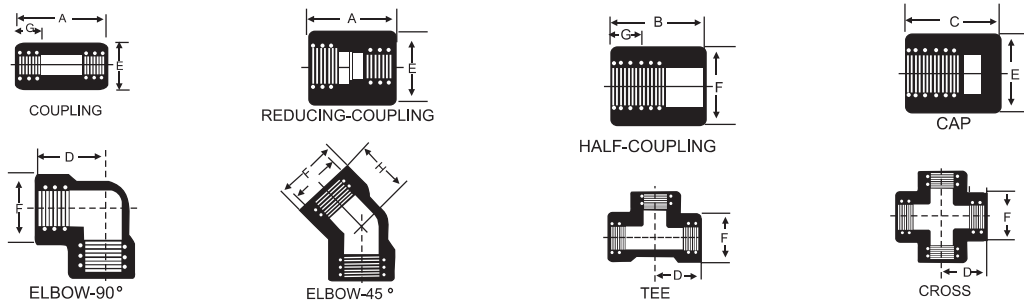

FORMULAE

- 1) WEIGHT OF STAINLESS STEEL PIPES & TUBES
 $\text{OD (mm) - W.T. (mm) X W.T. (mm) X 0.02466 = Kg. per Mtr.}$
- 2) SHEET WIDTH REQUIRED FOR ROLLED AND WELDED PIPES
 $\text{O.D. (mm) - THK (mm) X 3.14 = Sheet Width}$
- 3) WEIGHT OF STAINLESS STEEL SHEETS
 $\text{Length (mtr.) x Wdth (mtr.) X Thk (mm) X 8 = Kg Per Sheet}$
- 4) WEIGHT OF STAINLESS STEEL CIRCLE & BLANKS
 $\text{O.D. (mm) X O.D.> (mm) X Thk (mm) /160/1000 = Kg Per Pcs.}$
- 5) WEIGHT OF STAINLESS STEEL ROUNDS
 $\text{Dia. (mm) X Dia. (mm) X 0.00623 = Per Mtr.}$
- 6) WEIGHT OF STAINLESS STEEL HEXAGONAL RODS
 $\text{Dia. (mm) X Dia. (mm) X 0.00679 = Per Mtr.}$
- 7) WEIGHT OF STAINLESS STEEL SQUARE BARS
 $\text{Dia. (mm) X Dia. (mm) X 0.00787 = Kg Per Mtr.}$
- 8) WEIGHT OF CARBON STEEL PIPES & TUBES
 $\text{O.D. (mm) - W.T. (mm) X W.T. (mm) X 0.02466 = Kg. Per Mtr.}$
- 9) WEIGHT OF CARBON STEEL SHEETS - PLATES
 $\text{Length (mtr.) X Width (mtr.) X Thk (mm) X 7.85 = Kg. Pert Sheet}$
- 10) WEIGHT OF COPPER PIPES
 $\text{O.D. (mm) - W.T. (mm) X W.T. (mm) X 0.0256 = Kg. Per Mtr.}$
- 11) WEIGHT OF LEAD PIPES (appro.)
 $\text{O.D. (mm) - W.T. (mm) X W.T. (mm) X 0.0345 = Per Mtr.}$
- 12) WEIGHT OF LEAD SHEETS (appro.)
 $\text{Length (mtr.) X Width (mtr.) X Thk (mm) X 11.2 = Kg. Per Sheet}$
- 13) WEIGHT OF ALLUMINIUM PIPES (appro.)
 $\text{O.D. (mm) - W.T. (mm) X W.T. (mm) X 0.0082 = Kg. Per Mtr.}$
- 14) WEIGTH OF ALLUMINIUM SHEETS (appro.)
 $\text{Length (mtr.) X Width (mtr.) X Thk (mm) X 2.66 = Kg Per Sheet}$